



FIRSTATTEC

HSC-WERKZEUGE HSC-TOOLS



**BESTELLEN SIE GLEICH:
ORDER NOW:**

 **BESTELLSHOTLINE/ORDER HOTLINE:**
0 8000 150 250

 **E-MAIL/E-MAIL ORDERING:**
CONTACT@FIRSTATTEC.DE

 **IM INTERNET/ONLINE-SHOP:**
WWW.FIRSTATTEC.DE

 **FIRSTATTEC GMBH, CARL-BENZ-STR. 5**
68723 SCHWETZINGEN

FIRSTATTEC HSC-WERKZEUGE | FIRSTATTEC HSC-TOOLS

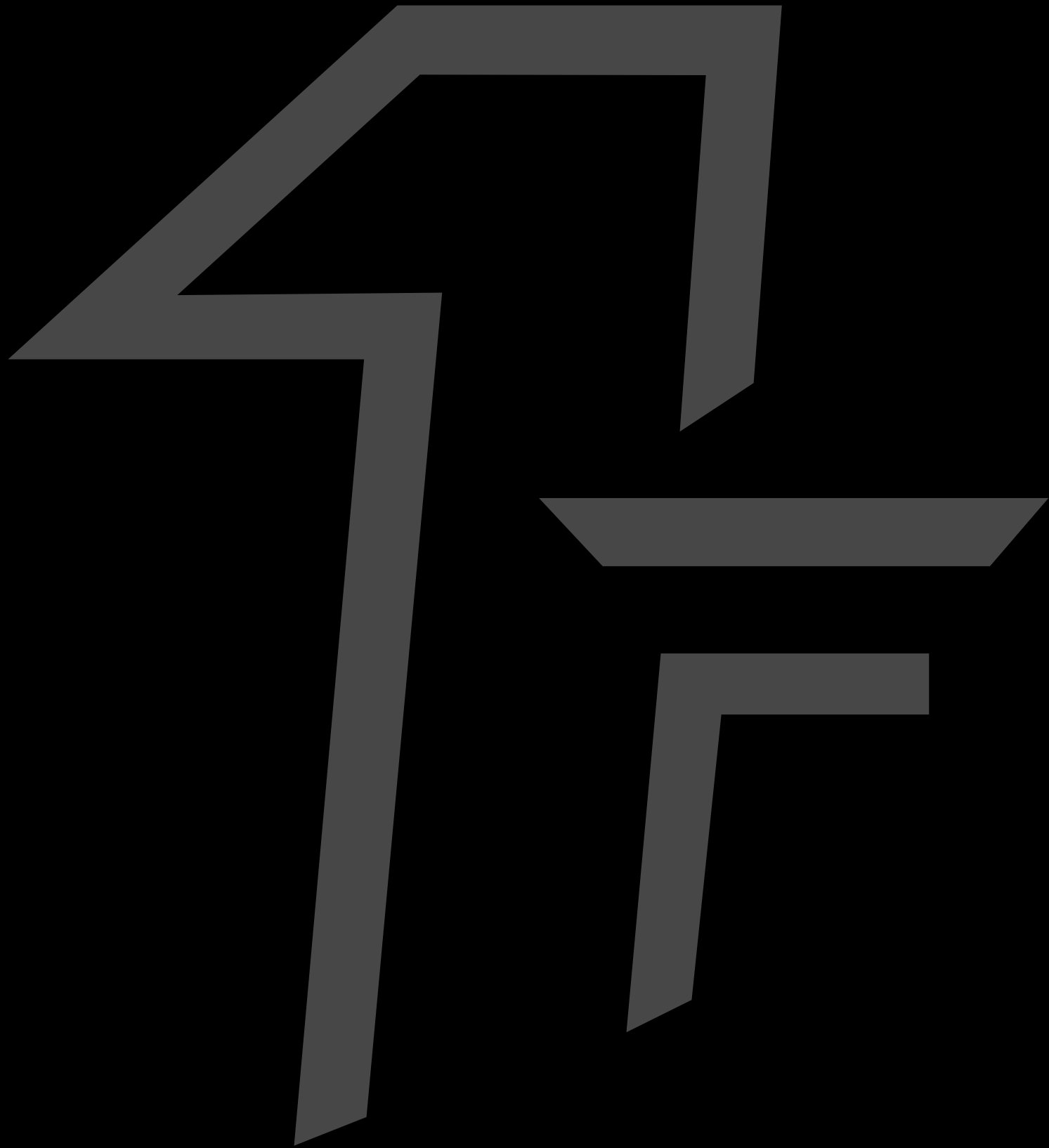

DIE ZUKUNFT DER HOCHGESCHWINDIGKEITSZERSPANUNG.

WELCOME TO THE FUTURE OF HIGH SPEED CUTTING.

Die Angaben in diesem Katalog wurden mit größter Sorgfalt und auf Richtigkeit hin geprüft. Jedoch kann für eventuell unvollständige oder fehlerhafte Angaben keine Haftung übernommen werden. Änderungen, die der technischen Weiterentwicklung dienen, behalten wir uns vor.

Every care was undertaken that the information stated in this catalogue is correct at the time of publication. However, in case of any information being incorrect no responsibility can be taken by the company. We reserve the right on changes that serve technical advancements.

FIRSTATTEC

INHALTSVERZEICHNIS

INHALT	4
FIRSTATTEC	8
BESTELLTIPPS	17
WERKZEUGE	18
LIEFERUNG & ZAHLUNG	126

SCHAFTFRÄSER 18

1-Schneider	21
1-Schneider, Beschichtet	23
1-Schneider, 1/8" Schaft	25
1-Schneider, Freischliff	26
1-Schneider, Linksdrall	27
1-Schneider, Schaftverstärkt	28
1-Schneider, Freischliff, Schaftverstärkt	29
1-Schneider, Hochpräzise	30
1-Schneider, Innenkühlung	31
1-Schneider, Poliert	33
2-Schneider	35
2-Schneider, Beschichtet	37
2-Schneider, 1/8" Schaft	38
2-Schneider, Freischliff	39
2-Schneider, Spanbrecher	40
2-Schneider, Hochpräzise	41
2-Schneider, Innenkühlung	43
3-Schneider	45
3-Schneider, Freischliff	46
3-Schneider, Abgestuft	47
3-Schneider, Schaumstoff	48
3-Schneider, Freischliff Schaumstoff	49

TORUSFRÄSER 50

1-Schneider	53
1-Schneider, Beschichtet	54
1-Schneider, Freischliff	55
2-Schneider	57
2-Schneider, Beschichtet	58
2-Schneider, Freischliff	59
3-Schneider, Abgestuft	61

VOLLRADIUSFRÄSER 62

1-Schneider	65
1-Schneider, Beschichtet	66
1-Schneider, 1/8" Schaft	67
1-Schneider, Freischliff	68
1-Schneider, Poliert	69

2-Schneider	71
2-Schneider, Beschichtet	72
2-Schneider, 1/8" Schaft	73
2-Schneider, Freischliff	75
3-Schneider	77
3-Schneider, Beschichtet	78
3-Schneider, Freischliff	79
3-Schneider, Schaumstoff	80
3-Schneider, Freischliff Schaumstoff	81

ENTGRATWERKZEUGE 82

Fasenfräser 3-Schneider	85
Fasenfräser 3-Schneider, Beschichtet	86
Fasenfräser 3-Schneider, 1/8" Schaft	87
Fasenfräser 3-Schneider, Schaumstoff	88
Fasenfräser 4-Schneider, Poliert	89
Vor- und Rückwärtsentgrater 3-Schneider	90
Rückwärtsentgrater 3-Schneider	91
Viertelkreisfräser 3-Schneider	92
Viertelkreisfräser 3-Schneider, Poliert	93

GRAVIERWERKZEUGE 94

Gravierstichel 1-Schneider	97
Gravierstichel 1-Schneider, 1/8" Schaft	99
Gravierstichel 1-Schneider, mit Radius	100
Gravierfräser 2-Schneider	101
Gravierfräser 2-Schneider, Spanbrecher	103

GEWINDEWERKZEUGE 104

Gewindewirbler 2/4-Schneider	107
Gewindewirbler 2/4-Schneider, Beschichtet	109
Gewindewirbler 2/4-Schneider, Multi	111
Gewindewirbler 2-Schneider, Poliert	112
Bohrgewindewirbler 3-Schneider	113

BOHRWERKZEUGE 114

Spiralbohrer 2-Schneider	117
Spiralbohrer 2-Schneider, Beschichtet	119

SPEZIALWERKZEUGE 114

Nutfräser 3-Schneider	121
Nutfräser 3-Schneider, Abgestuft	123

TABLE OF CONTENT

CONTENT	6
FIRSTATTEC	8
ORDER ADVICE	17
HSC-TOOLS	19
DELIVERY & PAYMENT	126

END MILL 19

1-Flute	21
1-Flute, Coated	23
1-Flute, 1/8" Shank	25
1-Flute, Reduced Neck	26
1-Flute, Left Hand Twist	27
1-Flute, Reinforced Shank	28
1-Flute, Reduced Neck, Reinforced Shank	29
1-Flute, High-Precision	30
1-Flute, Internal Cooling	31
1-Flute, Polished	33
2-Flute	35
2-Flute, Coated	37
2-Flute, 1/8" Shank	38
2-Flute, Reduced Neck	39
2-Flute, Chip Breaker	40
2-Flute, High-Precision	41
2-Flute, Internal Cooling	43
3-Flute	45
3-Flute, Reduced Neck	46
3-Flute, Stepped	47
3-Flute, Foam	48
3-Flute, Reduced Neck, Foam	49

TORIC END MILL 51

1-Flute	53
1-Flute, Coated	54
1-Flute, Reduced Neck	55
2-Flute	57
2-Flute, Coated	58
2-Flute, Reduced Neck	59
3-Flute, Stepped	61

BALL END MILL 63

1-Flute	65
1-Flute, Coated	66
1-Flute, 1/8" Shank	67
1-Flute, Reduced Neck	68
1-Flute, Polished	69

2-Flute	71
2-Flute, Coated	72
2-Flute, 1/8" Shank	73
2-Flute, Reduced Neck	75
3-Flute	77
3-Flute, Coated	78
3-Flute, Reduced Neck	79
3-Flute, Foam	80
3-Flute, Reduced Neck, Foam	81

DEBURRING TOOLS 83

Chamfer Milling Tool 3-Flute	85
Chamfer Milling Tool 3-Flute, Coated	86
Chamfer Milling Tool 3-Flute, 1/8" Shank	87
Chamfer Milling Tool 3-Flute, Foam	88
Chamfer Milling Tool 4-Flute, Polished	89
Chamfer Milling Tool Forward & Backward 3-Flute	90
Chamfer Milling Tool Backward 3-Flute	91
Corner Rounding Milling Tool 3-Flute	92
Corner Rounding Milling Tool 3-Flute, Polished	93

ENGRAVING TOOLS 95

Graver 1-Flute	97
Graver 1-Flute, 1/8" Shank	99
Graver 1-Flute, with Radius	100
Engraving Milling Tool 2-Flute	101
Engraving Milling Tool 2-Flute, Chip Breaker	103

THREAD TOOLS 105

Whirling Thread Cutter 2/4-Flute	107
Whirling Thread Cutter 2/4-Flute, Coated	109
Whirling Thread Cutter 2/4-Flute, Multi	111
Whirling Thread Cutter 2-Flute, Polished	112
Drilling-Whirling Thread Cutter 3-Flute	113

DRILLING TOOLS 115

Drilling Tool 2-Flute	117
Drilling Tool 2-Flute, Coated	119

SPECIAL TOOLS 115

Slotting Tool 3-Flute	121
Slotting Tool 3-Flute, Stepped	123



WIR BEGLEITEN SIE BEI IHREM PROJEKT

„Wir ermöglichen die Technik, Sie – das Finale. Mit unseren Produkten, die aus Leidenschaft und Verantwortung entstehen, sparen Sie Zeit, um sich auf Ihr Ziel zu fokussieren und Sie sparen Kraft, dieses zu erreichen.“

„We take care of the technology, you provide the final touch. Created with a passion for quality and a sense of responsibility, our products will save you time and energy to focus on and achieve your goals.“

Larissa Ritzhaupt, Director Marketing & Sales Strategy

„Damit für Ihre Herausforderungen optimale Lösungen gefunden werden, ist es unsere tägliche Aufgabe technologischen Fortschritt voranzutreiben.“

„Our daily work is to drive technological progress in order to find the best solutions for your challenges.“

Florian Ritzhaupt, Geschäftsführer/CEO



DER KUNDE IM MITTELPUNKT

QUALITÄT SEIT 1985

Seit 1985 vertrauen unsere Kunden auf Ritzhaupt-Qualität. Über die Jahre konnten wir uns am Markt als Hersteller fundiertes Fachwissen aneignen. Um jetzt auch in zweiter Generation richtungsweisend voranzugehen, war die einzig richtige Entscheidung den Vertrieb unserer Produkte mit der FIRSTATTEC GmbH selbst in die Hand zu nehmen. So sind wir näher an unseren Kunden und können gemeinsam, aber vor Allem frühzeitig reagieren. Unsere haus-eigene Produktion ermöglicht uns Flexibilität und Unabhängigkeit. Das alles kommt ab sofort unseren langjährigen und neuen Kunden zu Gute.

QUALITY SINCE 1985

Customers have been trusting in Ritzhaupt quality since 1985. Over the years, we have acquired sound manufacturing expertise in the market. To continue driving our business successfully in the second generation of family ownership, the next logical step was to establish our own company, FIRSTATTEC GmbH, and take product sales into our own hands. We are now closer to our customers and can react faster and more flexibly to their needs. Our in-house production provides for flexibility and self-determination, thus benefitting long-term and new customers alike.

„Hersteller zu sein bedeutet für uns Verantwortung zu übernehmen und Maßstäbe zu setzen.“

„For us, being a manufacturer means taking on responsibility and setting standards.“

Larissa Ritzhaupt, Director Marketing & Sales Strategy



ZUVERLÄSSIGKEIT



OHNE UMWEGE

Als einer der wenigen Hersteller Deutschlands sind wir ab sofort noch einen Schritt näher am Kunden. Das bedeutet noch passgenauere Lösungen bieten zu können. So findet unsere Schleiferfahrung seit über 30 Jahren den direkten Weg zum Kunden.

NÄCHSTE GENERATION

Wir treiben den Fortschritt weiter voran. Mit FIRSTATTEC sind wir also in der Lage, einen neuen Standard in der Branche zu setzen und effizientere Prozesse zu gestalten. Unser Verlangen nach überzeugender Qualität endet nicht beim Produkt, sondern beim Kunden. Wir leben das Prinzip unserer Eltern: Wenn wir etwas machen, dann richtig!

DIRECT ROUTES

As one of only a handful of German manufacturers, we are now a step closer to the customer. Cutting out the middlemen means that we can now offer even more bespoke solutions and give our customers direct access to our regrinding expertise based on 30 years of experience in the business.

THE NEXT GENERATION

FIRSTATTEC is driving progress forward. We are in position to set new standards in the industry and shape processes more efficiently. Our desire for convincing quality ends not with the product, but with the customer. We live the principle set down by our parents: whatever we do, we do it properly!



PROZESSOPTIMIERUNG

UNSER SERVICE

Unsere Kunden bekommen nicht nur ein Produkt, sondern auch prozess-optimierenden Service. Mit unserer innovativen Produktion im Rücken liefern wir passgenaue Lösungen und anspruchsvollen Service aus einer Hand: Von der Bearbeitung des Rohmaterials über die Qualitätssicherung bis hin zur Optimierung Ihres Bearbeitungsprozesses.

STRATEGISCH GEDACHT

Auf Wunsch optimieren unsere Techniker für Sie Ihre Bearbeitungsstrategie. So holen wir gemeinsam das Beste aus Ihrem Produktionsprozess. Abgenutzte Werkzeuge arbeiten wir mit unserem Nachschleifservice wieder für Sie auf. Sie sind dann mit annähernd gleicher Standzeit wiederverwendbar.

OUR SERVICES

Beyond supplying our customers with a product, we also provide process-optimizing services. Backed by our innovative production, we can deliver bespoke solutions and high-quality services from one source: from raw materials processing and quality assurance to an optimized processing chain.

STRATEGICALLY-MINDED

Upon request, our technicians will help you optimize your processing strategy to get the best out of your production process. We also provide a regrinding service to recondition worn tools and thus substantially extend their service life.

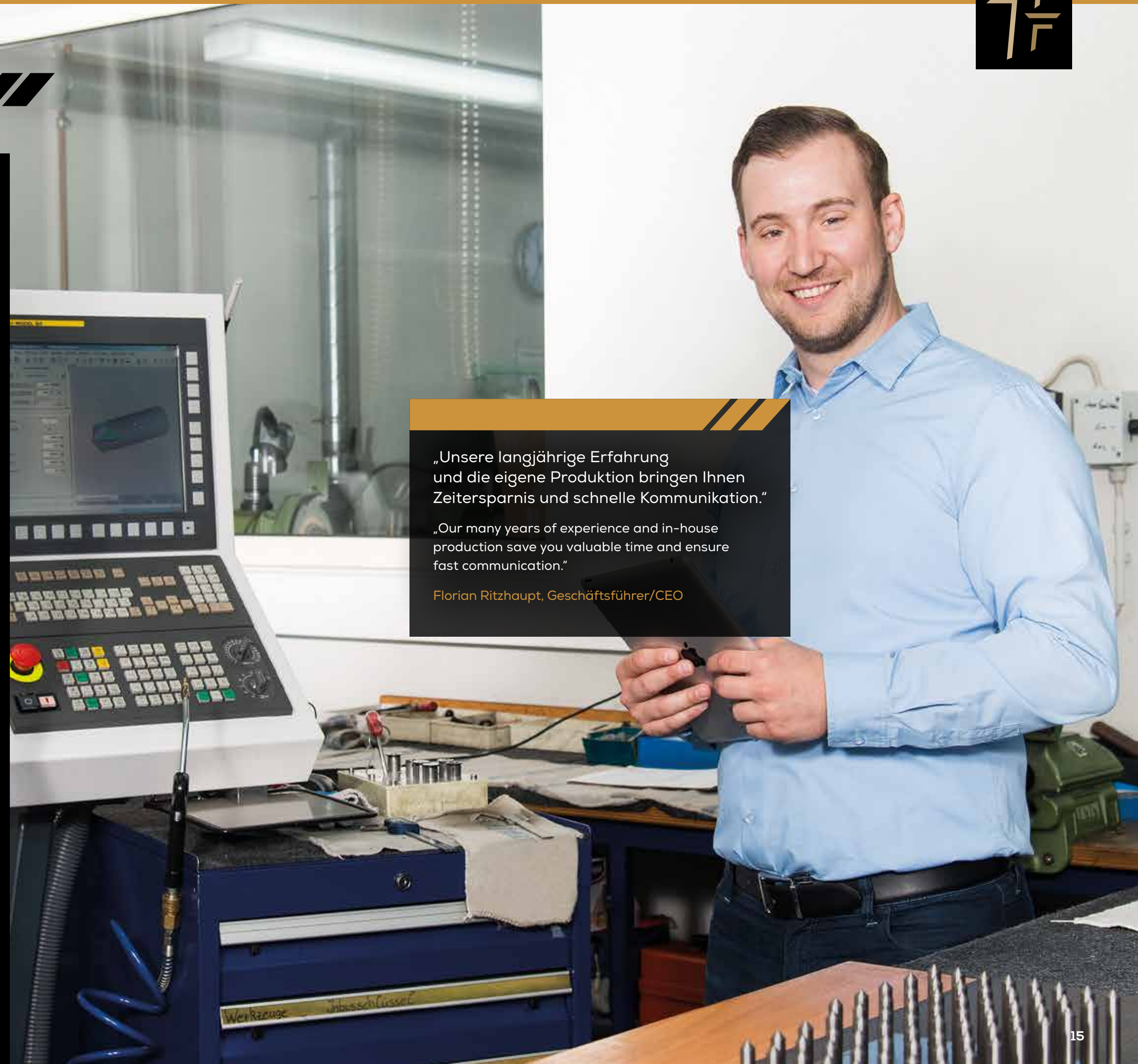

„Unsere langjährige Erfahrung und die eigene Produktion bringen Ihnen Zeitersparnis und schnelle Kommunikation.“

„Our many years of experience and in-house production save you valuable time and ensure fast communication.“

Florian Ritzhaupt, Geschäftsführer/CEO



FIRSTATTEC ARTIKELNUMMERN/ARTICLE NUMBERS

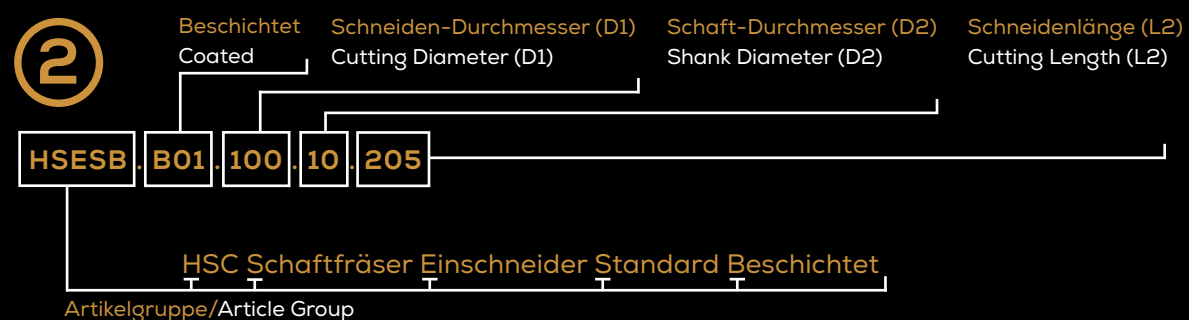
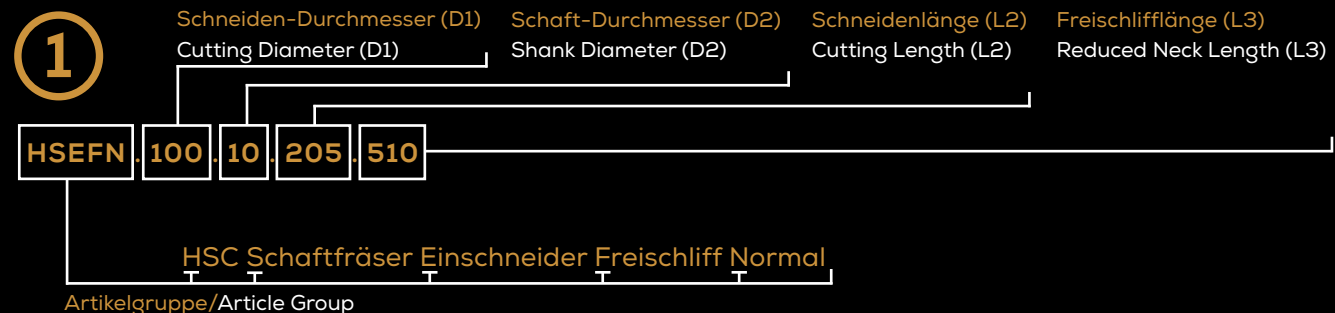

BESTELLTIPPS

SERVICE

ORDER ADVICE & SERVICE

Bestellen Sie innerhalb Deutschlands ab einem Warenwert von **99€** versandkostenfrei. Expresssendungen sind auf Anfrage möglich. Bestellungen vor 14:00 Uhr werden am gleichen Tag versendet (bei Lagervorhaltung). Lastschriftmandate sind möglich.

Orders within Germany from a value of €99 are free of shipping costs. Express shipments are possible on request. Orders placed before 2:00 pm will be shipped the same day (if in stock). SEPA Direct debit mandates are possible.

INDIVIDUELL FÜR SIE DA



BESTELHOTLINE/ORDER HOTLINE:
0 8000 150 250



E-MAIL/E-MAIL ORDERING:
CONTACT@FIRSTATTEC.DE



IM INTERNET/ONLINE-SHOP:
WWW.FIRSTATTEC.DE

ZAHLUNGSARTEN



RECHNUNG
BILL PAYMENT



SEPA LASTSCHRIFT
SEPA DIRECT DEBIT

Liefer- und Zahlungsbedingungen auf Seite 126
Terms of Payment and Delivery on Page 126



-5% > 5 STK. > 5 PCS.	-10% > 10 STK. > 10 PCS.	-20% > 20 STK. > 20 PCS.
------------------------------------	---------------------------------------	---------------------------------------

Beachten Sie bei der Bestellung unsere Mengenrabatte!
Gilt bei Bestellungen identischer Artikel.

Consider our quantity discounts for your order!
Applies to orders of the same article number.

FIRSTATTEC





HSC-SCHAFTFRÄSER		ALUMINIUM	ALUMINIUM ELOXIERT	MESSING	KUPFER	KUNSTSTOFF	ACRYL	SCHAUMSTOFF	VORAUSWAHL		
									(MM)	(MM)	(KATALOG)
									D1	D2	SEITE
HSESN.	1-Schneider	●	●	●	●	●	●	●	0.3-10.0	3.0-10.0	21
HSESB.	1-Schneider Beschichtet	●	●	●	●	●	●	●	1.0-10.0	3.0-10.0	23
HSEZN.	1-Schneider 1/8" Schaft	●	●	●	●	●	●	●	0.3-3.175	3.175	25
HSEFN.	1-Schneider Freischliff	●	●	●	●	●	●	●	1.0-10.0	3.0-10.0	26
HSELN.	1-Schneider Linksdrall	●	●	●	●	●	●	●	1.0-8.0	3.0-8.0	27
HSEKN.	1-Schneider Schaftverstärkt	●	●	●	●	●	●	●	3.0-8.0	8.0-10.0	28
HSEKF.	1-Schneider Freischliff Schaftverstärkt	●	●	●	●	●	●	●	3.0-8.0	8.0-10.0	29
HSEHN.	1-Schneider Hochpräzise	●	●	●	●	●	●	●	3.0-10.0	3.0-10.0	30
HSEIN.	1-Schneider Innenkühlung	●	●	●	●	●	●	●	6.0-10.0	6.0-10.0	31
HSEPN.	1-Schneider Poliert	●	●	●	●	●	●	●	1.0-10.0	3.0-10.0	33
HSZSN.	2-Schneider	●	●	●	●	●	●	●	0.3-10.0	3.0-10.0	35
HSZSB.	2-Schneider Beschichtet	●	●	●	●	●	●	●	1.0-10.0	3.0-10.0	37
HSZZN.	2-Schneider 1/8" Schaft	●	●	●	●	●	●	●	0.3-3.175	3.175	38
HSZFN.	2-Schneider Freischliff	●	●	●	●	●	●	●	0.5-10.0	3.0-10.0	39
HSZBN.	2-Schneider Spanbrecher	●	●	●	●	●	●	●	6.0-10.0	6.0-10.0	40
HSZHN.	2-Schneider Hochpräzise	●	●	●	●	●	●	●	1.0-10.0	3.0-10.0	41
HSZIN.	2-Schneider Innenkühlung	●	●	●	●	●	●	●	6.0-10.0	6.0-10.0	43
HSDSN.	3-Schneider	●	●	●	●	●	●	●	1.0-10.0	3.0-10.0	45
HSDFN.	3-Schneider Freischliff	●	●	●	●	●	●	●	1.0-10.0	3.0-10.0	46
HSDAN.	3-Schneider Abgestuft	●	●	●	●	●	●	●	8.0-20.0	6.0-10.0	47
HSDWN.	3-Schneider Schaumstoff	●	●	●	●	●	●	●	3.0-10.0	3.0-10.0	48
HSDWF.	3-Schneider Freischliff Schaumstoff	●	●	●	●	●	●	●	3.0-10.0	6.0-10.0	49

HSC-END MILL		ALUMINIUM	ALUMINIUM ANODIZED	BRASS	COPPER	PLASTIC	ACRYLIC	FOAM	PRESELECTION		
									(MM)	(MM)	(KATALOG)
									D1	D2	PAGE
HSESN.	1-Flute	●	●	●	●	●	●	●	0.3-10.0	3.0-10.0	21
HSESB.	1-Flute Coated	●	●	●	●	●	●	●	1.0-10.0	3.0-10.0	23
HSEZN.	1-Flute 1/8" Shank	●	●	●	●	●	●	●	0.3-3.175	3.175	25
HSEFN.	1-Flute Reduced Neck	●	●	●	●	●	●	●	1.0-10.0	3.0-10.0	26
HSELN.	1-Flute Left Hand Twist	●	●	●	●	●	●	●	1.0-8.0	3.0-8.0	27
HSEKN.	1-Flute Reinforced Shank	●	●	●	●	●	●	●	3.0-8.0	8.0-10.0	28
HSEKF.	1-Flute Reduced Neck Reinforced Shank	●	●	●	●	●	●	●	3.0-8.0	8.0-10.0	29
HSEHN.	1-Flute High-Precision	●	●	●	●	●	●	●	3.0-10.0	3.0-10.0	30
HSEIN.	1-Flute Internal Cooling	●	●	●	●	●	●	●	6.0-10.0	6.0-10.0	31
HSEPN.	1-Flute Polished	●	●	●	●	●	●	●	1.0-10.0	3.0-10.0	33
HSZSN.	2-Flute	●	●	●	●	●	●	●	0.3-10.0	3.0-10.0	35
HSZSB.	2-Flute Coated	●	●	●	●	●	●	●	1.0-10.0	3.0-10.0	37
HSZZN.	2-Flute 1/8" Shank	●	●	●	●	●	●	●	0.3-3.175	3.175	38
HSZFN.	2-Flute Reduced Neck	●	●	●	●	●	●	●	0.5-10.0	3.0-10.0	39
HSZBN.	2-Flute Chipbreaker	●	●	●	●	●	●	●	6.0-10.0	6.0-10.0	40
HSZHN.	2-Flute High-Precision	●	●	●	●	●	●	●	1.0-10.0	3.0-10.0	41
HSZIN.	2-Flute Internal Cooling	●	●	●	●	●	●	●	6.0-10.0	6.0-10.0	43
HSDSN.	3-Flute	●	●	●	●	●	●	●	1.0-10.0	3.0-10.0	45
HSDFN.	3-Flute Reduced Neck	●	●	●	●	●	●	●	1.0-10.0	3.0-10.0	46
HSDAN.	3-Flute Stepped	●	●	●	●	●	●	●	8.0-20.0	6.0-10.0	47
HSDWN.	3-Flute Foam	●	●	●	●	●	●	●	3.0-10.0	3.0-10.0	48
HSDWF.	3-Flute Reduced Neck Foam	●	●	●	●	●	●	●	3.0-10.0	6.0-10.0	49



• BE FAST. BE FIRST. BE FIRSTATTEC •

SCHAFTFRÄSER

1-SCHNEIDER END MILL 1-FLUTE

Multitalent in der HSC-Zerspanung.
Multitalent in High-Speed Machining.

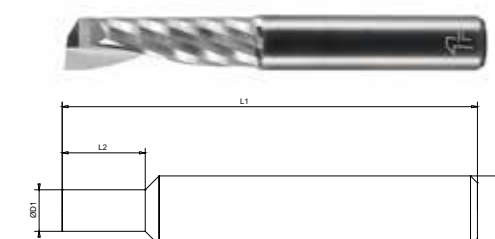

ALU
ALUMINIUM

ALU
ELOXIERT
ANODIZED
ALU

KUNST
STOFF
PLASTIC

**FIRSTATTEC –
WEIL ES FUNKTIONIERT.
FIRSTATTEC – IT WORKS.**

ART.-NR. ARTICLE-CODE	GEWINDE THREAD	D1 (h9)	D2 (h6)	D3	L1	L2	L3	R	α	PREIS PRICE
		(mm)	(mm)	(mm)	(mm)	(mm)	(mm)	(mm)		€/STK. €/PC.
HSESN.										
003.03.010		0.3	3.0		40.0	1.0				17,00 €
005.03.015		0.5	3.0		40.0	1.5				16,00 €
006.03.015		0.6	3.0		40.0	1.5				12,80 €
008.03.020		0.8	3.0		40.0	2.0				12,80 €
010.03.025		1.0	3.0		40.0	2.5				12,00 €
010.03.045		1.0	3.0		40.0	4.5				12,00 €
010.06.055		1.0	6.0		50.0	5.5				23,00 €
015.03.045		1.5	3.0		40.0	4.5				12,00 €
015.06.065		1.5	6.0		50.0	6.5				22,00 €
020.03.055		2.0	3.0		40.0	5.5				12,00 €
020.03.075		2.0	3.0		40.0	7.5				12,00 €
020.06.055		2.0	6.0		50.0	5.5				20,00 €
020.06.065		2.0	6.0		50.0	6.5				21,00 €
020.06.075		2.0	6.0		50.0	7.5				21,00 €
020.06.085		2.0	6.0		50.0	8.5				22,00 €
020.06.105		2.0	6.0		50.0	10.5				23,00 €

→ Fortsetzung auf Seite 22
Continued on page 22

-5%	-10%	-20%
> 5 STK.	> 10 STK.	> 20 STK.
> 5 PCS.	> 10 PCS.	> 20 PCS.



FIRSTATTEC

FIRSTATTEC GMBH | CARL-BENZ-STR. 5 | 68723 SCHWETZINGEN
☎ 0 8000 150 250 | CONTACT@FIRSTATTEC.DE ☎
• WWW.FIRSTATTEC.DE •



ART.-NR. ARTICLE-CODE	GEWINDE THREAD	D1 (h9)	D2 (h6)	D3	L1	L2	L3	R	α	PREIS
		(mm)	(mm)							(mm)
HSESN.										
024.03.085		2.4	3.0		40.0	8.5				12,00 €
024.03.105		2.4	3.0		40.0	10.5				12,00 €
030.03.055		3.0	3.0		40.0	5.5				12,00 €
030.03.085		3.0	3.0		40.0	8.5				12,00 €
030.03.105		3.0	3.0		40.0	10.5				12,00 €
030.06.055		3.0	6.0		50.0	5.5				20,00 €
030.06.065		3.0	6.0		50.0	6.5				20,00 €
030.06.085		3.0	6.0		50.0	8.5				21,00 €
030.06.095		3.0	6.0		50.0	9.5				21,00 €
030.06.125		3.0	6.0		50.0	12.5				22,00 €
040.06.055		4.0	6.0		50.0	5.5				22,00 €
040.06.085		4.0	6.0		50.0	8.5				22,00 €
040.06.105		4.0	6.0		50.0	10.5				23,00 €
040.06.120		4.0	6.0		50.0	12.0				23,00 €
040.06.155		4.0	6.0		50.0	15.5				23,00 €
050.06.105		5.0	6.0		50.0	10.5				22,00 €
050.06.185		5.0	6.0		50.0	18.5				23,00 €
060.06.085		6.0	6.0		50.0	8.5				21,00 €
060.06.125		6.0	6.0		50.0	12.5				22,00 €
060.06.140		6.0	6.0		50.0	14.0				22,00 €
060.06.155		6.0	6.0		50.0	15.5				22,00 €
060.06.205		6.0	6.0		60.0	20.5				24,00 €
060.06.255		6.0	6.0		60.0	25.5				26,00 €
060.06.305		6.0	6.0		70.0	30.5				29,00 €
080.08.165		8.0	8.0		50.0	16.5				28,00 €
080.08.265		8.0	8.0		60.0	26.5				32,00 €
080.08.325		8.0	8.0		70.0	32.5				36,00 €
100.10.205		10.0	10.0		60.0	20.5				35,00 €
100.10.405		10.0	10.0		80.0	40.5				45,00 €

SCHAFTFRÄSER

1-SCHNEIDER, BESCHICHTET END MILL 1-FLUTE, COATED

Multitalent in der HSC-Zerspanung.
Modernste Beschichtungstechnologie für längere Standzeiten.

Multitalent in High-Speed Machining.
Cutting edge coating technology for longer tool life.

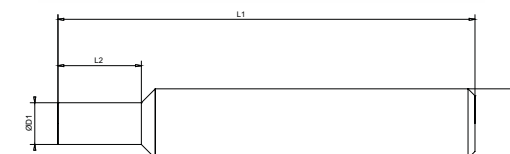

ART.-NR. ARTICLE-CODE	GEWINDE THREAD	D1 (h9)	D2 (h6)	D3	L1	L2	L3	R	α	PREIS PRICE
		(mm)	(mm)							(mm)
HSESB.										
B01.010.03.025		1.0	3.0		40.0	2.5				20,00 €
B01.010.03.045		1.0	3.0		40.0	4.5				22,00 €
B01.010.06.055		1.0	6.0		50.0	5.5				32,00 €
B01.015.03.045		1.5	3.0		40.0	4.5				21,00 €
B01.015.06.065		1.5	6.0		50.0	6.5				31,00 €
B01.020.03.055		2.0	3.0		40.0	5.5				20,00 €
B01.020.03.075		2.0	3.0		40.0	7.5				21,00 €
B01.020.06.055		2.0	6.0		50.0	5.5				29,00 €
B01.020.06.065		2.0	6.0		50.0	6.5				30,00 €
B01.020.06.075		2.0	6.0		50.0	7.5				30,00 €
B01.020.06.085		2.0	6.0		50.0	8.5				31,00 €
B01.020.06.105		2.0	6.0		50.0	10.5				32,00 €
B01.030.03.055		3.0	3.0		40.0	5.5				20,00 €
B01.030.03.085		3.0	3.0		40.0	8.5				20,00 €
B01.030.03.105		3.0	3.0		40.0	10.5				21,00 €
B01.030.06.055		3.0	6.0		50.0	5.5				29,00 €

→ Fortsetzung auf Seite 24
Continued on page 24

-5%	-10%	-20%
> 5 STK.	> 10 STK.	> 20 STK.
> 5 PCS.	> 10 PCS.	> 20 PCS.

FIRSTATTEC

FIRSTATTEC



ART.-NR. ARTICLE-CODE	GEWINDE THREAD	D1 (h9)	D2 (h6)	D3	L1	L2	L3	R	α	PREIS
		(mm)	(mm)							(mm)
HSESB.										
B01.030.06.065		3.0	6.0		50.0	6.5				29,00 €
B01.030.06.085		3.0	6.0		50.0	8.5				30,00 €
B01.030.06.095		3.0	6.0		50.0	9.5				30,00 €
B01.030.06.125		3.0	6.0		50.0	12.5				31,00 €
B01.040.06.055		4.0	6.0		50.0	5.5				30,00 €
B01.040.06.085		4.0	6.0		50.0	8.5				31,00 €
B01.040.06.105		4.0	6.0		50.0	10.5				31,00 €
B01.040.06.155		4.0	6.0		50.0	15.5				32,00 €
B01.050.06.105		5.0	6.0		50.0	10.5				31,00 €
B01.050.06.185		5.0	6.0		50.0	18.5				32,00 €
B01.060.06.085		6.0	6.0		50.0	8.5				30,00 €
B01.060.06.125		6.0	6.0		50.0	12.5				31,00 €
B01.060.06.155		6.0	6.0		50.0	15.5				31,00 €
B01.060.06.205		6.0	6.0		60.0	20.5				34,00 €
B01.060.06.255		6.0	6.0		60.0	25.5				35,00 €
B01.060.06.305		6.0	6.0		70.0	30.5				38,00 €
B01.080.08.165		8.0	8.0		50.0	16.5				40,00 €
B01.080.08.265		8.0	8.0		60.0	26.5				44,00 €
B01.080.08.325		8.0	8.0		70.0	32.5				48,00 €
B01.100.10.205		10.0	10.0		60.0	20.5				52,00 €
B01.100.10.405		10.0	10.0		80.0	40.5				61,00 €

EXTREM SCHNELL, EXTREM GENAU



SCHAFTFRÄSER

**1-SCHNEIDER, 1/8" SCHAFT
END MILL 1-FLUTE, 1/8" SHANK**

Multitalent in der HSC-Zerspanung.
Multitalent in High-Speed Machining.

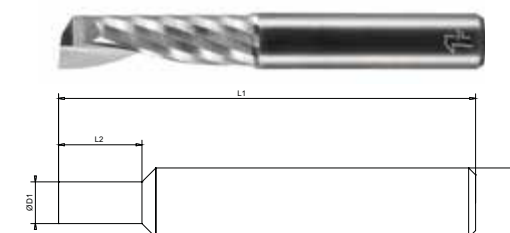

ART.-NR. ARTICLE-CODE	GEWINDE THREAD	D1 (h9)	D2 (h6)	D3	L1	L2	L3	R	α	PREIS PRICE
		(mm)	(mm)							(mm)
HSEZN.										
003.18.010		0.3	3.175		40.0	1.0				16,00 €
005.18.015		0.5	3.175		40.0	1.5				15,00 €
006.18.015		0.6	3.175		40.0	1.5				11,80 €
008.18.020		0.8	3.175		40.0	2.0				11,80 €
010.18.025		1.0	3.175		40.0	2.5				11,00 €
010.18.045		1.0	3.175		40.0	4.5				11,00 €
012.18.045		1.2	3.175		40.0	4.5				11,00 €
015.18.045		1.5	3.175		40.0	4.5				11,00 €
020.18.055		2.0	3.175		40.0	5.5				11,00 €
020.18.075		2.0	3.175		40.0	7.5				11,00 €
020.18.105		2.0	3.175		40.0	10.5				11,00 €
024.18.085		2.4	3.175		40.0	8.5				11,00 €
030.18.055		3.0	3.175		40.0	5.5				11,00 €
030.18.085		3.0	3.175		40.0	8.5				11,00 €
030.18.125		3.0	3.175		40.0	12.5				11,00 €
180.18.125		3.175	3.175		40.0	12.5				11,00 €

-5% > 5 STK. | -10% > 10 STK. | -20% > 20 STK.
> 5 PCS. | > 10 PCS. | > 20 PCS.

FIRSTATTEC



SCHAFTFRÄSER

1-SCHNEIDER, FREISCHLIFF END MILL 1-FLUTE, REDUCED NECK

Multitalent in der HSC-Zerspanung für die Tiefenbearbeitung.

Multitalent in High-Speed Depth Machining.

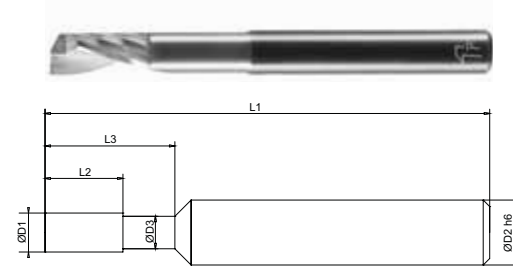

ALU
ALUMINIUM

ALU
ELOXIERT
ANODIZED
ALU

KUNST
STOFF
PLASTIC

ART.-NR. ARTICLE-CODE	GEWINDE THREAD	D1 (h9)	D2 (h6)	D3 (mm)	L1 (mm)	L2 (mm)	L3 (mm)	R (mm)	α	PREIS PRICE
		(mm)	(mm)							€/STK. €/PC.
HSEFN.										
010.03.025.070	1.0	3.0	0.9	40.0	2.5	7.0				20,00 €
010.06.025.110	1.0	6.0	0.9	50.0	2.5	11.0				29,00 €
020.03.055.110	2.0	3.0	1.8	50.0	5.5	11.0				19,00 €
020.06.065.160	2.0	6.0	1.8	50.0	6.5	16.0				27,00 €
030.03.055.130	3.0	3.0	2.8	50.0	5.5	13.0				19,00 €
030.03.055.160	3.0	3.0	2.8	50.0	5.5	16.0				20,00 €
030.06.065.180	3.0	6.0	2.8	60.0	6.5	18.0				26,00 €
030.06.065.210	3.0	6.0	2.8	60.0	6.5	21.0				27,00 €
040.06.085.210	4.0	6.0	3.7	60.0	8.5	21.0				28,00 €
050.06.105.260	5.0	6.0	4.6	60.0	10.5	26.0				28,00 €
060.06.125.260	6.0	6.0	5.5	60.0	12.5	26.0				27,00 €
060.06.125.310	6.0	6.0	5.5	70.0	12.5	31.0				29,00 €
060.06.125.360	6.0	6.0	5.5	70.0	12.5	36.0				29,00 €
080.08.165.410	8.0	8.0	7.5	80.0	16.5	41.0				37,00 €
080.08.165.460	8.0	8.0	7.5	80.0	16.5	46.0				37,00 €
100.10.205.510	10.0	10.0	9.5	90.0	20.5	51.0				47,00 €

-5% > 5 STK. > 5 PCS. | -10% > 10 STK. > 10 PCS. | -20% > 20 STK. > 20 PCS.

FIRSTATTEC



SCHAFTFRÄSER

1-SCHNEIDER, LINKSDRALL END MILL 1-FLUTE, LEFT HAND TWIST

Multitalent in der HSC-Zerspanung.
Keine Materialanhebung, da Schnittkräfte auf -Z.

Multitalent in High-Speed Machining.
No lifting of the material, because cutting pressure on -Z.

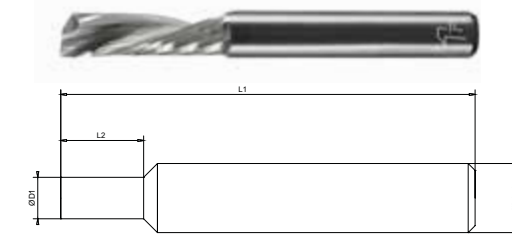

ALU
ALUMINIUM

ALU
ELOXIERT
ANODIZED
ALU

KUNST
STOFF
PLASTIC

ART.-NR. ARTICLE-CODE	GEWINDE THREAD	D1 (h9)	D2 (h6)	D3 (mm)	L1 (mm)	L2 (mm)	L3 (mm)	R (mm)	α	PREIS PRICE
		(mm)	(mm)							€/STK. €/PC.
HSELN.										
010.03.045	1.0	3.0		40.0	4.5					17,00 €
020.03.075	2.0	3.0		40.0	7.5					16,00 €
030.03.085	3.0	3.0		40.0	8.5					15,00 €
030.06.105	3.0	6.0		50.0	10.5					23,00 €
040.06.125	4.0	6.0		50.0	12.5					25,00 €
050.06.155	5.0	6.0		50.0	15.5					25,00 €
060.06.125	6.0	6.0		50.0	12.5					24,00 €
060.06.205	6.0	6.0		60.0	20.5					27,00 €
080.08.265	8.0	8.0		70.0	26.5					34,00 €

-5% > 5 STK. > 5 PCS. | -10% > 10 STK. > 10 PCS. | -20% > 20 STK. > 20 PCS.

FIRSTATTEC

SCHAFTFRÄSER
TORUSFRÄSER
VOLLRADIUSFRÄSER
ENTGRATWERKZEUGE
GRAVIERWERKZEUGE
GEWINDEWERKZEUGE
BOHRWERKZEUGE
SPEZIALWERKZEUGE



SCHAFTFRÄSER

1-SCHNEIDER, SCHAFTVERSTÄRKT END MILL 1-FLUTE, REINFORCED SHANK

Multitalent in der HSC-Zerspanung z.B. von schwingungsanfälligen Aluminiumprofilen.

Multitalent in High-Speed Machining, e.g. for aluminium profiles.

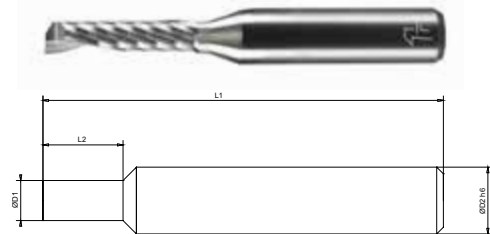

ALU
ALUMINIUM

ALU
ELOXIERT
ANODIZED
ALU

ART.-NR. ARTICLE-CODE	GEWINDE THREAD	D1 (h9)	D2 (h6)	D3 (mm)	L1 (mm)	L2 (mm)	L3 (mm)	R (mm)	α	PREIS PRICE
		(mm)	(mm)							€/STK. €/PC.
HSEKN.										
030.08.065		3.0	8.0		50.0	6.5				27,00 €
030.08.095		3.0	8.0		50.0	9.5				28,00 €
030.08.125		3.0	8.0		50.0	12.5				29,00 €
040.08.085		4.0	8.0		50.0	8.5				28,00 €
040.08.155		4.0	8.0		60.0	15.5				31,00 €
050.08.105		5.0	8.0		50.0	10.5				28,00 €
050.08.185		5.0	8.0		60.0	18.5				31,00 €
060.10.125		6.0	10.0		50.0	12.5				28,00 €
060.10.155		6.0	10.0		60.0	15.5				30,00 €
060.10.205		6.0	10.0		60.0	20.5				31,00 €
060.10.255		6.0	10.0		70.0	25.5				34,00 €
060.10.305		6.0	10.0		70.0	30.5				35,00 €
080.10.165		8.0	10.0		50.0	16.5				33,00 €
080.10.265		8.0	10.0		60.0	26.5				37,00 €
080.10.325		8.0	10.0		70.0	32.5				41,00 €

-5% > 5 STK. | -10% > 10 STK. | -20% > 20 STK.
> 5 PCS. | > 10 PCS. | > 20 PCS.

FIRSTATTEC



SCHAFTFRÄSER

1-SCHNEIDER, FREISCHLIFF, SCHAFTVERSTÄRKT END MILL 1-FLUTE, REDUCED NECK, REINFORCED SHANK

Multitalent in der HSC-Zerspanung für die Tiefenbearbeitung z.B. von schwingungsanfälligen Aluminiumprofilen.

Multitalent in High-Speed Depth Machining, e.g. for aluminium profiles.

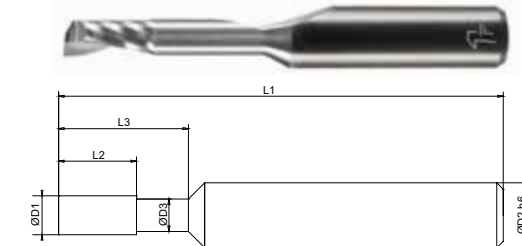

ALU
ALUMINIUM

ALU
ELOXIERT
ANODIZED
ALU

ART.-NR. ARTICLE-CODE	GEWINDE THREAD	D1 (h9)	D2 (h6)	D3 (mm)	L1 (mm)	L2 (mm)	L3 (mm)	R (mm)	α	PREIS PRICE
		(mm)	(mm)							€/STK. €/PC.
HSEKF.										
030.08.065.160		3.0	8.0	2.8	60.0	6.5	16.0			36,00 €
030.08.065.210		3.0	8.0	2.8	60.0	6.5	21.0			38,00 €
040.08.085.210		4.0	8.0	3.8	60.0	8.5	21.0			37,00 €
050.08.105.260		5.0	8.0	4.8	60.0	10.5	26.0			37,00 €
060.10.125.310		6.0	10.0	5.8	70.0	12.5	31.0			40,00 €
060.10.125.360		6.0	10.0	5.8	70.0	12.5	36.0			41,00 €
080.10.165.410		8.0	10.0	7.8	80.0	16.5	41.0			46,00 €

-5% > 5 STK. | -10% > 10 STK. | -20% > 20 STK.
> 5 PCS. | > 10 PCS. | > 20 PCS.

FIRSTATTEC

SCHAFTFRÄSER
TORUSFRÄSER
VOLLRADIUSFRÄSER
ENTGRATWERKZEUGE
GRAVIERWERKZEUGE
GEWINDEWERKZEUGE
BOHRWERKZEUGE
SPEZIALWERKZEUGE



SCHAFTFRÄSER

1-SCHNEIDER, HOCHPRÄZISE END MILL 1-FLUTE, HIGH-PRECISION

Multitalent in der HSC-Zerspanung. Enges Toleranzfeld (h6) des Fräsdurchmessers, perfekt zum Schlichten.

Multitalent in High-Speed Machining. Limited tolerance field (h6) of the milling diameter, perfect for finishing.

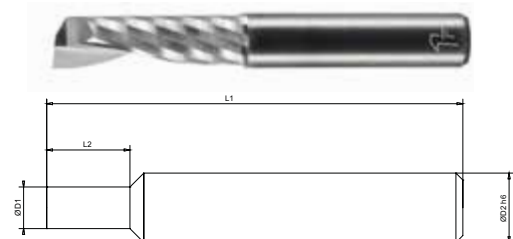

ART.-NR. ARTICLE-CODE	GEWINDE THREAD	D1 (h6)	D2 (h6)	D3	L1	L2	L3	R	α	PREIS PRICE
		(mm)	(mm)							(mm)
HSEHN.										
030.03.055		3.0	3.0		40.0	5.5				19,00 €
030.03.085		3.0	3.0		40.0	8.5				19,00 €
030.06.065		3.0	6.0		50.0	6.5				26,00 €
030.06.125		3.0	6.0		50.0	12.5				28,00 €
040.06.155		4.0	6.0		50.0	15.5				29,00 €
050.06.185		5.0	6.0		60.0	18.5				29,00 €
060.06.125		6.0	6.0		50.0	12.5				28,00 €
060.06.205		6.0	6.0		60.0	20.5				31,00 €
060.06.305		6.0	6.0		70.0	30.5				35,00 €
080.08.165		8.0	8.0		50.0	16.5				36,00 €
080.08.325		8.0	8.0		70.0	32.5				44,00 €
100.10.205		10.0	10.0		60.0	20.5				44,00 €
100.10.405		10.0	10.0		80.0	40.5				53,00 €

-5%	-10%	-20%
> 5 STK.	> 10 STK.	> 20 STK.
> 5 PCS.	> 10 PCS.	> 20 PCS.

FIRSTATTEC



SCHAFTFRÄSER

1-SCHNEIDER, INNENKÜHLUNG END MILL 1-FLUTE, INTERNAL COOLING

Multitalent in der HSC-Zerspanung. Fräs Werkzeug mit zweifacher, axialen Innenkühlung.

Multitalent in High-Speed Machining. Milling tool with double, axial internal cooling.

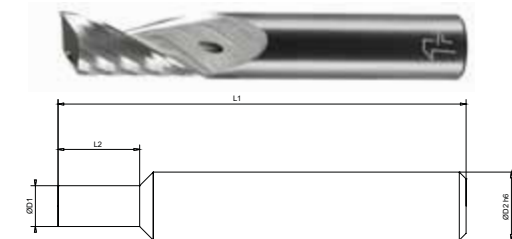

ART.-NR. ARTICLE-CODE	GEWINDE THREAD	D1 (h9)	D2 (h6)	D3	L1	L2	L3	R	α	PREIS PRICE
		(mm)	(mm)							(mm)
HSEIN.										
060.06.125		6.0	6.0		50.0	12.5				34,00 €
060.06.155		6.0	6.0		50.0	15.5				34,00 €
060.06.205		6.0	6.0		60.0	20.5				37,00 €
060.06.255		6.0	6.0		60.0	25.5				38,00 €
060.06.305		6.0	6.0		70.0	30.5				41,00 €
080.08.165		8.0	8.0		50.0	16.5				46,00 €
080.08.265		8.0	8.0		60.0	26.5				50,00 €
080.08.325		8.0	8.0		70.0	32.5				54,00 €
100.10.205		10.0	10.0		60.0	20.5				60,00 €
100.10.305		10.0	10.0		70.0	30.5				65,00 €
100.10.405		10.0	10.0		80.0	40.5				69,00 €

-5%	-10%	-20%
> 5 STK.	> 10 STK.	> 20 STK.
> 5 PCS.	> 10 PCS.	> 20 PCS.

FIRSTATTEC



EXPERTISE IN JEDEM WERKZEUG

SCHAFTFRÄSER

1-SCHNEIDER, POLIERT END MILL 1-FLUTE, POLISHED

Multitalent in der HSC-Zerspanung, speziell für nahezu durchsichtige Acryl-Konturen.

Multitalent in High-Speed Machining, especially for almost transparent acrylic contours.

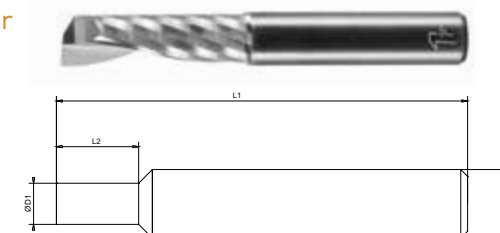

KUNSTSTOFF
PLASTIC

ACRYL
ACRYLIC

ART.-NR. ARTICLE-CODE	GEWINDE THREAD	D1 (h9)	D2 (h6)	D3	L1	L2	L3	R	α	PREIS PRICE
		(mm)	(mm)							(mm)
HSEPN.										
010.03.045		1.0	3.0		40.0	4.5				22,00 €
010.06.055		1.0	6.0		50.0	5.5				30,00 €
015.03.045		1.5	3.0		40.0	4.5				21,00 €
015.06.065		1.5	6.0		50.0	6.5				29,00 €
020.03.075		2.0	3.0		40.0	7.5				21,00 €
020.06.105		2.0	6.0		50.0	10.5				30,00 €
030.03.085		3.0	3.0		40.0	8.5				20,00 €
030.06.125		3.0	6.0		50.0	12.5				29,00 €
030.06.155		3.0	6.0		50.0	15.5				30,00 €
040.06.125		4.0	6.0		50.0	12.5				30,00 €
040.06.205		4.0	6.0		60.0	20.5				34,00 €
050.06.155		5.0	6.0		50.0	15.5				30,00 €
050.06.255		5.0	6.0		60.0	25.5				34,00 €
060.06.125		6.0	6.0		50.0	12.5				29,00 €
060.06.205		6.0	6.0		60.0	20.5				32,00 €
060.06.305		6.0	6.0		70.0	30.5				36,00 €
080.08.265		8.0	8.0		60.0	26.5				41,00 €
080.08.405		8.0	8.0		80.0	40.5				49,00 €
100.10.305		10.0	10.0		70.0	30.5				53,00 €
100.10.505		10.0	10.0		90.0	50.5				62,00 €

-5%	-10%	-20%
> 5 STK.	> 10 STK.	> 20 STK.
> 5 PCS.	> 10 PCS.	> 20 PCS.

FIRSTATTEC

FIRSTATTEC



SCHAFTFRÄSER

2-SCHNEIDER END MILL 2-FLUTE

Universal Fräs Werkzeug zur Zerspaltung von NE-Metallen.

Universal milling tool for cutting non-ferrous metals.

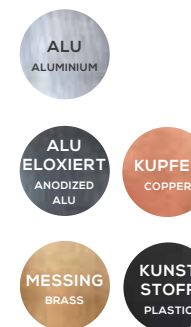
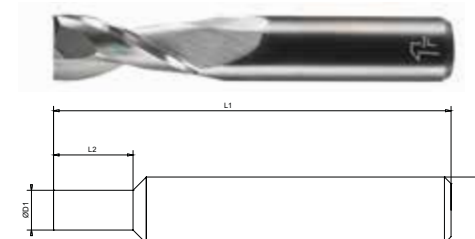

ART.-NR. ARTICLE-CODE	GEWINDE THREAD	D1 (h9)	D2 (h6)	D3	L1	L2	L3	R	α	PREIS PRICE
		(mm)	(mm)	(mm)	(mm)	(mm)	(mm)	(mm)		€/STK. €/PC.
HSZSN.										
001.03.002		0.1	3.0		40.0	0.2				68,00 €
002.03.004		0.2	3.0		40.0	0.4				38,00 €
003.03.010		0.3	3.0		40.0	1.0				19,00 €
004.03.010		0.4	3.0		40.0	1.0				18,00 €
005.03.015		0.5	3.0		40.0	1.5				18,00 €
006.03.015		0.6	3.0		40.0	1.5				12,80 €
008.03.020		0.8	3.0		40.0	2.0				12,80 €
010.03.025		1.0	3.0		40.0	2.5				12,00 €
010.03.045		1.0	3.0		40.0	4.5				12,00 €
015.03.045		1.5	3.0		40.0	4.5				12,00 €
020.03.045		2.0	3.0		40.0	4.5				12,00 €
020.03.085		2.0	3.0		40.0	8.5				12,00 €
030.03.065		3.0	3.0		40.0	6.5				12,00 €
030.03.095		3.0	3.0		40.0	9.5				12,00 €
030.06.095		3.0	6.0		50.0	9.5				21,00 €
030.06.125		3.0	6.0		50.0	12.5				22,00 €

→ Fortsetzung auf Seite 36
Continued on page 36

-5%	-10%	-20%
> 5 STK.	> 10 STK.	> 20 STK.
> 5 PCS.	> 10 PCS.	> 20 PCS.

FIRSTATTEC

ART.-NR. ARTICLE-CODE	GEWINDE THREAD	D1 (h9)	D2 (h6)	D3	L1	L2	L3	R	α	PREIS
		(mm)	(mm)							(mm)
HSZSN.										
040.06.085		4.0	6.0		50.0	8.5				22,00 €
040.06.125		4.0	6.0		50.0	12.5				23,00 €
050.06.105		5.0	6.0		50.0	10.5				22,00 €
050.06.155		5.0	6.0		50.0	15.5				23,00 €
060.06.125		6.0	6.0		50.0	12.5				22,00 €
060.06.185		6.0	6.0		50.0	18.5				23,00 €
060.06.245		6.0	6.0		60.0	24.5				26,00 €
080.08.165		8.0	8.0		50.0	16.5				28,00 €
080.08.265		8.0	8.0		60.0	26.5				32,00 €
100.10.205		10.0	10.0		60.0	20.5				36,00 €
100.10.305		10.0	10.0		70.0	30.5				41,00 €



WERKZEUGE MIT CHARAKTER

- 5%
> 5 STK.
> 5 PCS.
- 10%
> 10 STK.
> 10 PCS.
- 20%
> 20 STK.
> 20 PCS.

FIRSTATTEC



SCHAFTFRÄSER

**2-SCHNEIDER, BESCHICHTET
END MILL 2-FLUTE, COATED**

Universal Fräs Werkzeug zur Zerspannung von NE-Metallen. Modernste Beschichtungstechnologie für längere Standzeiten.

Universal milling tool for cutting non-ferrous metals. Cutting edge coating technology for longer tool life.

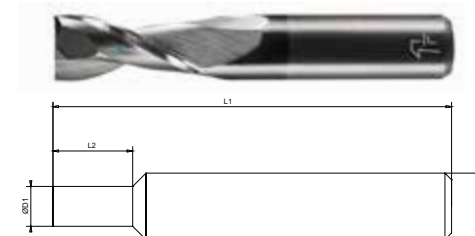

ART.-NR. ARTICLE-CODE	GEWINDE THREAD	D1 (h9)	D2 (h6)	D3	L1	L2	L3	R	α	PREIS PRICE
		(mm)	(mm)							(mm)
HSZSB.										
B01.010.03.025		1.0	3.0		40.0	2.5				20,00 €
B01.010.03.045		1.0	3.0		40.0	4.5				22,00 €
B01.015.03.045		1.5	3.0		40.0	4.5				21,00 €
B01.020.03.045		2.0	3.0		40.0	4.5				20,00 €
B01.020.03.085		2.0	3.0		40.0	8.5				22,00 €
B01.030.03.065		3.0	3.0		40.0	6.5				20,00 €
B01.030.03.095		3.0	3.0		40.0	9.5				21,00 €
B01.030.06.095		3.0	6.0		50.0	9.5				30,00 €
B01.030.06.125		3.0	6.0		50.0	12.5				31,00 €
B01.040.06.085		4.0	6.0		50.0	8.5				31,00 €
B01.040.06.125		4.0	6.0		50.0	12.5				32,00 €
B01.050.06.105		5.0	6.0		50.0	10.5				31,00 €
B01.050.06.155		5.0	6.0		50.0	15.5				32,00 €
B01.060.06.125		6.0	6.0		50.0	12.5				31,00 €
B01.060.06.185		6.0	6.0		50.0	18.5				32,00 €
B01.060.06.245		6.0	6.0		60.0	24.5				35,00 €
B01.080.08.165		8.0	8.0		50.0	16.5				40,00 €
B01.080.08.265		8.0	8.0		60.0	26.5				44,00 €
B01.100.10.205		10.0	10.0		60.0	20.5				52,00 €
B01.100.10.305		10.0	10.0		70.0	30.5				57,00 €

FIRSTATTEC



SCHAFTFRÄSER

2-SCHNEIDER, 1/8" SCHAFT END MILL 2-FLUTE, 1/8" SHANK

Universal Fräs Werkzeug zur Zerspaltung von NE-Metallen.

Universal milling tool for cutting non-ferrous metals.

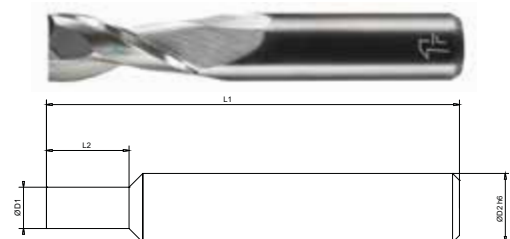

ART.-NR. ARTICLE-CODE	GEWINDE THREAD	D1 (h9)	D2 (h6)	D3 (mm)	L1 (mm)	L2 (mm)	L3 (mm)	R (mm)	α	PREIS PRICE
		(mm)	(mm)							€/STK. €/PC.
HSZZN.										
003.18.010		0.3	3.175		40.0	1.0				18,00 €
005.18.015		0.5	3.175		40.0	1.5				17,00 €
006.18.015		0.6	3.175		40.0	1.5				11,80 €
008.18.020		0.8	3.175		40.0	2.0				11,80 €
010.18.025		1.0	3.175		40.0	2.5				11,00€
010.18.045		1.0	3.175		40.0	4.5				11,00€
015.18.045		1.5	3.175		40.0	4.5				11,00€
015.18.065		1.5	3.175		40.0	6.5				11,00€
020.18.045		2.0	3.175		40.0	4.5				11,00€
020.18.085		2.0	3.175		40.0	8.5				11,00€
024.18.085		2.4	3.175		40.0	8.5				11,00€
030.18.065		3.0	3.175		40.0	6.5				11,00€
030.18.095		3.0	3.175		40.0	9.5				11,00€
030.18.125		3.0	3.175		40.0	12.5				11,00€
180.18.125		3.175	3.175		40.0	12.5				11,00€

-5% > 5 STK. > 5 PCS. | -10% > 10 STK. > 10 PCS. | -20% > 20 STK. > 20 PCS.

FIRSTATTEC



SCHAFTFRÄSER

2-SCHNEIDER, FREISCHLIFF END MILL 2-FLUTE, REDUCED NECK

Universal Fräs Werkzeug zur Zerspaltung von NE-Metallen. Geeignet für die Tiefenbearbeitung.

Universal milling tool for cutting non-ferrous metals in depth machining.

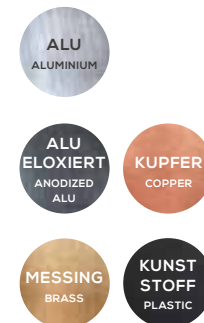
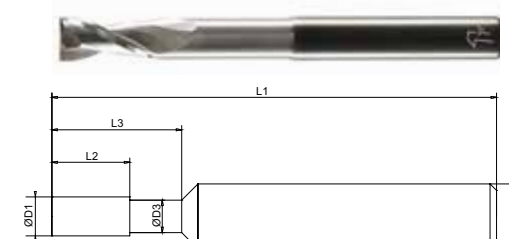

ART.-NR. ARTICLE-CODE	GEWINDE THREAD	D1 (h9)	D2 (h6)	D3 (mm)	L1 (mm)	L2 (mm)	L3 (mm)	R (mm)	α	PREIS PRICE
		(mm)	(mm)							€/STK. €/PC.
HSZFN.										
005.03.015.050		0.5	3.0	0.4	40.0	1.5	5.0			26,00 €
010.03.025.050		1.0	3.0	0.9	40.0	2.5	5.0			19,00 €
010.03.025.080		1.0	3.0	0.9	40.0	2.5	8.0			20,00 €
015.03.045.110		1.5	3.0	1.4	50.0	4.5	11.0			21,00 €
020.03.045.110		2.0	3.0	1.9	50.0	4.5	11.0			19,00 €
020.03.045.160		2.0	3.0	1.9	50.0	4.5	16.0			20,00 €
030.03.065.130		3.0	3.0	2.8	50.0	6.5	13.0			19,00 €
030.03.065.160		3.0	3.0	2.8	50.0	6.5	16.0			20,00 €
030.06.095.180		3.0	6.0	2.8	60.0	9.5	18.0			27,00 €
030.06.095.210		3.0	6.0	2.8	60.0	9.5	21.0			28,00 €
040.06.085.210		4.0	6.0	3.7	60.0	8.5	21.0			28,00 €
050.06.105.260		5.0	6.0	4.6	60.0	10.5	26.0			28,00 €
060.06.125.260		6.0	6.0	5.5	60.0	12.5	26.0			27,00 €
060.06.125.310		6.0	6.0	5.5	70.0	12.5	31.0			29,00 €
080.08.165.410		8.0	8.0	7.5	80.0	16.5	41.0			37,00 €
100.10.205.510		10.0	10.0	9.5	90.0	20.5	51.0			47,00 €

-5% > 5 STK. > 5 PCS. | -10% > 10 STK. > 10 PCS. | -20% > 20 STK. > 20 PCS.

FIRSTATTEC



SCHAFTFRÄSER

2-SCHNEIDER, SPANBRECHER END MILL 2-FLUTE, CHIP BREAKER

Fräswerkzeug zur Zerspaltung von NE-Metallen. Geeignet für die Schruppbearbeitung, da sehr kurze Späne entstehen.

Milling tool for cutting non-ferrous metals. Suitable for roughing, as short chips are formed.

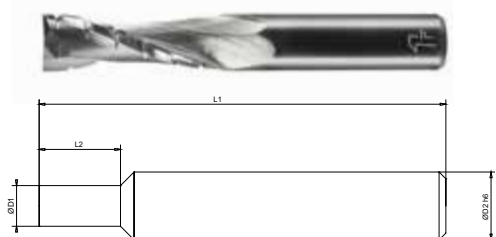

ART.-NR. ARTICLE-CODE	GEWINDE THREAD	D1 (h9)	D2 (h6)	D3	L1	L2	L3	R	α	PREIS PRICE
		(mm)	(mm)							(mm)
HSZBN.										
060.06.125		6.0	6.0		60.0	12.5				29,00 €
060.06.185		6.0	6.0		60.0	18.5				30,00 €
060.06.245		6.0	6.0		70.0	24.5				33,00 €
060.06.305		6.0	6.0		80.0	30.5				36,00 €
080.08.165		8.0	8.0		60.0	16.5				37,00 €
080.08.265		8.0	8.0		70.0	26.5				41,00 €
080.08.325		8.0	8.0		80.0	32.5				45,00 €
080.08.405		8.0	8.0		90.0	40.5				53,00 €
100.10.205		10.0	10.0		70.0	20.5				47,00 €
100.10.305		10.0	10.0		80.0	30.5				52,00 €
100.10.405		10.0	10.0		90.0	40.5				56,00 €
100.10.505		10.0	10.0		100.0	50.5				65,00 €

-5% > 5 STK. > 5 PCS. | -10% > 10 STK. > 10 PCS. | -20% > 20 STK. > 20 PCS.

FIRSTATTEC



SCHAFTFRÄSER

2-SCHNEIDER, HOCHPRÄZISE END MILL 2-FLUTE, HIGH-PRECISION

Universal Fräswerkzeug zur Zerspaltung von NE-Metallen. Enges Toleranzfeld (h6) des Fräsdurchmessers, perfekt zum Schlichten.

Universal milling tool for cutting non-ferrous metals. Limited tolerance field (h6) of the milling diameter, perfect for finishing.

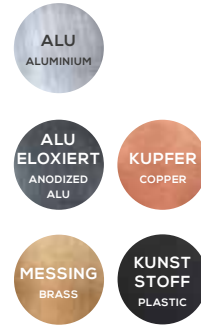
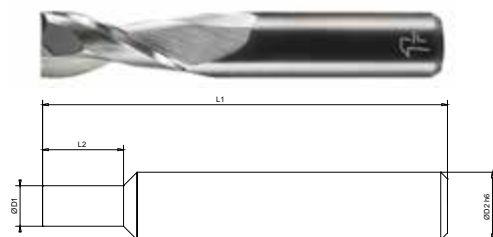

ART.-NR. ARTICLE-CODE	GEWINDE THREAD	D1 (h6)	D2 (h6)	D3	L1	L2	L3	R	α	PREIS PRICE
		(mm)	(mm)							(mm)
HSZHN.										
010.03.045		1.0	3.0		40.0	4.5				23,00 €
020.03.085		2.0	3.0		40.0	8.5				23,00 €
030.03.065		3.0	3.0		40.0	6.5				21,00 €
030.03.095		3.0	3.0		40.0	9.5				22,00 €
030.06.125		3.0	6.0		50.0	12.5				30,00 €
040.06.085		4.0	6.0		50.0	8.5				30,00 €
040.06.125		4.0	6.0		50.0	12.5				31,00 €
050.06.105		5.0	6.0		50.0	10.5				30,00 €
050.06.155		5.0	6.0		50.0	15.5				31,00 €
060.06.125		6.0	6.0		50.0	12.5				30,00 €
060.06.245		6.0	6.0		60.0	24.5				34,00 €
080.08.165		8.0	8.0		50.0	16.5				37,00 €
080.08.265		8.0	8.0		60.0	26.5				41,00 €
100.10.205		10.0	10.0		60.0	20.5				46,00 €
100.10.305		10.0	10.0		70.0	30.5				51,00 €

-5% > 5 STK. > 5 PCS. | -10% > 10 STK. > 10 PCS. | -20% > 20 STK. > 20 PCS.

FIRSTATTEC



VOM PROTOTYP ZUR SERIENPRODUKTION

SCHAFTFRÄSER

2-SCHNEIDER, INNENKÜHLUNG END MILL 2-FLUTE, INTERNAL COOLING

Universal Fräswerkzeug zur Zerspanung von NE-Metallen. Fräswerkzeug mit vierfacher, radialer Innenkühlung.

Universal milling tool for cutting non-ferrous metals. Milling tool with quadruple, radial internal cooling.

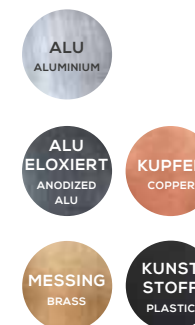
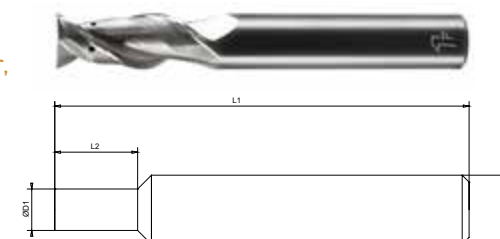

ART.-NR. ARTICLE-CODE	GEWINDE THREAD	D1 (h9)	D2 (h6)	D3	L1	L2	L3	R	α	PREIS PRICE
		(mm)	(mm)							(mm)
HSZIN.										
060.06.125		6.0	6.0		50.0	12.5				50,00 €
060.06.185		6.0	6.0		50.0	18.5				51,00 €
060.06.245		6.0	6.0		60.0	24.5				54,00 €
060.06.305		6.0	6.0		70.0	30.5				57,00 €
080.08.165		8.0	8.0		50.0	16.5				62,00 €
080.08.265		8.0	8.0		60.0	26.5				66,00 €
080.08.325		8.0	8.0		70.0	32.5				70,00 €
080.08.405		8.0	8.0		80.0	40.5				78,00 €
100.10.205		10.0	10.0		60.0	20.5				80,00 €
100.10.305		10.0	10.0		70.0	30.5				85,00 €
100.10.405		10.0	10.0		80.0	40.5				89,00 €
100.10.505		10.0	10.0		90.0	50.5				98,00 €

-5%	-10%	-20%
> 5 STK.	> 10 STK.	> 20 STK.
> 5 PCS.	> 10 PCS.	> 20 PCS.

FIRSTATTEC



SCHAFTFRÄSER

3-SCHNEIDER END MILL 3-FLUTE

Universal Fräs Werkzeug zur Zerspanung von NE-Metallen. Schlichtfräser für hohe Oberflächengüte.

Universal milling tool for cutting non-ferrous metals and for high surface quality.

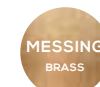
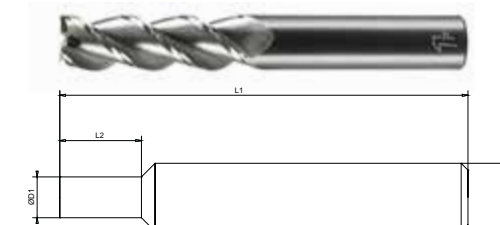

ART.-NR. ARTICLE-CODE	GEWINDE THREAD	D1 (h9)	D2 (h6)	D3	L1	L2	L3	R	α	PREIS PRICE
		(mm)	(mm)	(mm)	(mm)	(mm)	(mm)	(mm)		€/STK. €/PC.
HSDSN.										
010.03.025		1.0	3.0		40.0	2.5				16,00 €
010.06.045		1.0	6.0		50.0	4.5				24,00 €
020.03.045		2.0	3.0		40.0	4.5				16,00 €
020.06.085		2.0	6.0		50.0	8.5				24,00 €
030.03.065		3.0	3.0		40.0	6.5				16,00 €
030.06.105		3.0	6.0		50.0	10.5				23,00 €
040.06.085		4.0	6.0		50.0	8.5				24,00 €
040.06.125		4.0	6.0		50.0	12.5				25,00 €
050.06.105		5.0	6.0		50.0	10.5				24,00 €
050.06.155		5.0	6.0		50.0	15.5				25,00 €
060.06.125		6.0	6.0		50.0	12.5				24,00 €
060.06.185		6.0	6.0		50.0	18.5				25,00 €
060.06.245		6.0	6.0		60.0	24.5				28,00 €
080.08.165		8.0	8.0		50.0	16.5				30,00 €
080.08.265		8.0	8.0		60.0	26.5				34,00 €
100.10.205		10.0	10.0		60.0	20.5				38,00 €
100.10.305		10.0	10.0		70.0	30.5				43,00 €

-5%
> 5 STK.
> 5 PCS.

-10%
> 10 STK.
> 10 PCS.

-20%
> 20 STK.
> 20 PCS.

FIRSTATTEC



SCHAFTFRÄSER

3-SCHNEIDER, FREISCHLIFF END MILL 3-FLUTE, REDUCED NECK

Universal Fräs Werkzeug zur Zerspaltung von NE-Metallen für die Tiefenbearbeitung sowie für hohe Oberflächengüte.

Universal milling tool for cutting non-ferrous metals for depth machining and high surface quality.

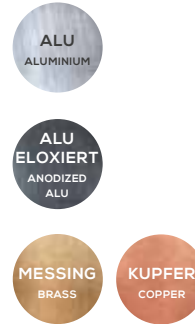
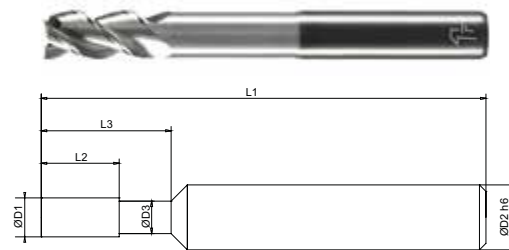

ART.-NR. ARTICLE-CODE	GEWINDE THREAD	D1 (h9)	D2 (h6)	D3 (mm)	L1 (mm)	L2 (mm)	L3 (mm)	R (mm)	α	PREIS PRICE
		(mm)	(mm)							€/STK. €/PC.
HSDFN.										
010.03.025.080		1.0	3.0	0.9	40.0	2.5	8.0			22,00 €
020.03.045.110		2.0	3.0	1.9	50.0	4.5	11.0			21,00 €
030.03.065.130		3.0	3.0	2.8	50.0	6.5	13.0			21,00 €
030.06.105.180		3.0	6.0	2.8	60.0	10.5	18.0			29,00 €
040.06.085.210		4.0	6.0	3.7	60.0	8.5	21.0			30,00 €
050.06.105.260		5.0	6.0	4.6	60.0	10.5	26.0			30,00 €
060.06.125.260		6.0	6.0	5.5	60.0	12.5	26.0			29,00 €
060.06.125.310		6.0	6.0	5.5	70.0	12.5	31.0			31,00 €
080.08.165.410		8.0	8.0	7.5	80.0	16.5	41.0			39,00 €
100.10.205.510		10.0	10.0	9.5	90.0	20.5	51.0			49,00 €

-5% > 5 STK. > 5 PCS. | -10% > 10 STK. > 10 PCS. | -20% > 20 STK. > 20 PCS.

FIRSTATTEC



SCHAFTFRÄSER

3-SCHNEIDER, ABGESTUFT END MILL 3-FLUTE, STEPPED

Fräs Werkzeug zur Zerspaltung von NE-Metallen. Großer Fräsdurchmesser zum Überfräsen großer Oberflächen.

Milling tool for cutting non-ferrous metals. Large milling diameter for milling large surfaces.

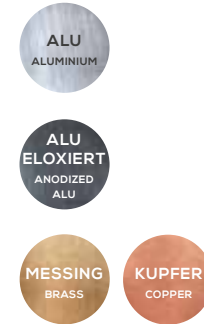
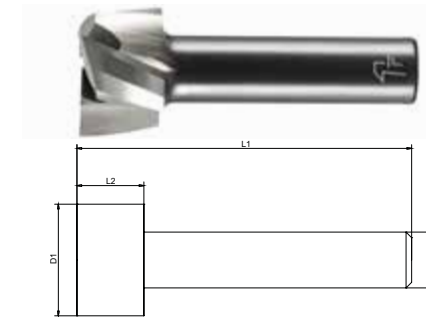

ART.-NR. ARTICLE-CODE	GEWINDE THREAD	D1 (h9)	D2 (h6)	D3 (mm)	L1 (mm)	L2 (mm)	L3 (mm)	R (mm)	α	PREIS PRICE
		(mm)	(mm)							€/STK. €/PC.
HSDAN.										
080.06.080		8.0	6.0		50.0	8.0				48,00 €
100.06.080		10.0	6.0		50.0	8.0				65,00 €
100.08.100		10.0	8.0		50.0	10.0				65,00 €
120.06.080		12.0	6.0		50.0	8.0				85,00 €
120.08.100		12.0	8.0		50.0	10.0				85,00 €
120.10.120		12.0	10.0		50.0	12.0				85,00 €
140.08.100		14.0	8.0		50.0	10.0				110,00 €
140.10.120		14.0	10.0		50.0	12.0				110,00 €
200.10.120		20.0	10.0		50.0	12.0				148,00 €

-5% > 5 STK. > 5 PCS. | -10% > 10 STK. > 10 PCS. | -20% > 20 STK. > 20 PCS.

FIRSTATTEC

SCHAFTFRÄSER
TORUSFRÄSER
VOLLRADIUSFRÄSER
ENTGRATWERKZEUGE
GRAVIERWERKZEUGE
GEWINDEWERKZEUGE
BOHRWERKZEUGE
SPEZIALWERKZEUGE



SCHAFTFRÄSER

3-SCHNEIDER, SCHAUMSTOFF END MILL 3-FLUTE, FOAM

Fräs Werkzeug zur Zerspänung von Schaumstoffen.

Milling tool for cutting foam.

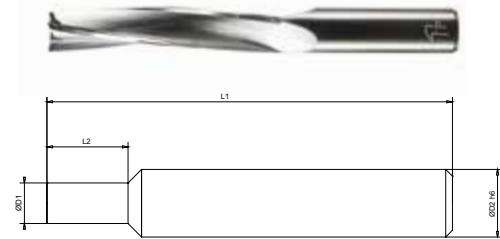

ART.-NR. ARTICLE-CODE	GEWINDE THREAD	D1 (h9)	D2 (h6)	D3	L1	L2	L3	R	α	PREIS PRICE
		(mm)	(mm)							(mm)
HSDWN.										
030.03.105		3.0	3.0		50.0	10.5				30,00 €
030.06.155		3.0	6.0		50.0	15.5				41,00 €
040.06.205		4.0	6.0		60.0	20.5				45,00 €
050.06.255		5.0	6.0		60.0	25.5				47,00 €
060.06.185		6.0	6.0		50.0	18.5				47,00 €
060.06.305		6.0	6.0		70.0	30.5				53,00 €
080.08.405		8.0	8.0		80.0	40.5				64,00 €
100.10.505		10.0	10.0		90.0	50.5				81,00 €

-5%	-10%	-20%
> 5 STK.	> 10 STK.	> 20 STK.
> 5 PCS.	> 10 PCS.	> 20 PCS.

FIRSTATTEC



SCHAFTFRÄSER

3-SCHNEIDER, FREISCHLIFF, SCHAUMSTOFF END MILL 3-FLUTE, REDUCED NECK, FOAM

Fräs Werkzeug zur Zerspänung von Schaumstoffen. Geeignet für die Tiefenbearbeitung.

Milling tool for cutting foam in depth machining.

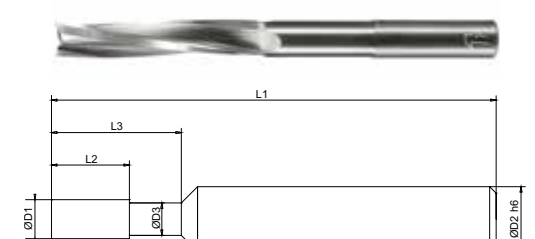

ART.-NR. ARTICLE-CODE	GEWINDE THREAD	D1 (h9)	D2 (h6)	D3	L1	L2	L3	R	α	PREIS PRICE
		(mm)	(mm)							(mm)
HSDWF.										
030.06.105.310		3.0	6.0	2.5	70.0	10.5	31.0			44,00 €
040.06.125.410		4.0	6.0	3.5	80.0	12.5	41.0			48,00 €
050.06.155.510		5.0	6.0	4.5	90.0	15.5	51.0			51,00 €
060.06.185.610		6.0	6.0	5.5	100.0	18.5	61.0			56,00 €
080.08.265.710		8.0	8.0	7.5	110.0	26.5	71.0			70,00 €
100.10.305.810		10.0	10.0	9.5	120.0	30.5	81.0			88,00 €

-5%	-10%	-20%
> 5 STK.	> 10 STK.	> 20 STK.
> 5 PCS.	> 10 PCS.	> 20 PCS.

FIRSTATTEC

SCHAFTFRÄSER
TORUSFRÄSER
VOLLRADIUSFRÄSER
ENTGRATWERKZEUGE
GRAVIERWERKZEUGE
GEWINDEWERKZEUGE
BOHRWERKZEUGE
SPEZIALWERKZEUGE



HSC-TORUSFRÄSER		ALUMINIUM	ALUMINIUM ELOXIERT	MESSING	KUPFER	KUNSTSTOFF	ACRYL	SCHAUMSTOFF	VORAUSWAHL		
									(MM)	(MM)	(KATALOG)
									D1	R	SEITE
HTESN.	1-Schneider	●	●	●	●	●	●		3.0-10.0	0.5-2.0	53
HTESB.	1-Schneider Beschichtet	●	●	●	●				3.0-10.0	0.5-2.0	54
HTEFN.	1-Schneider Freischliff	●	●	●	●	●	●		3.0-10.0	0.5-2.0	55
HTZSN.	2-Schneider	●	●	●	●	●	●		3.0-10.0	0.5-2.0	57
HTZSB.	2-Schneider Beschichtet	●	●	●	●				3.0-10.0	0.5-2.0	58
HTZFN.	2-Schneider Freischliff	●	●	●	●	●	●		3.0-10.0	0.5-2.0	59
HTDAN.	3-Schneider Abgestuft	●	●	●	●	●	●		8.0-20.0	0.5	61

HSC-TORIC END MILL		ALUMINIUM	ALUMINIUM ANODIZED	BRASS	COPPER	PLASTIC	ACRYLIC	FOAM	PRESELECTION		
									(MM)	(MM)	(KATALOG)
									D1	R	PAGE
HTESN.	1-Flute	●	●	●	●	●	●		3.0-10.0	0.5-2.0	53
HTESB.	1-Flute Coated	●	●	●	●				3.0-10.0	0.5-2.0	54
HTEFN.	1-Flute Reduced Neck	●	●	●	●	●	●		3.0-10.0	0.5-2.0	55
HTZSN.	2-Flute	●	●	●	●	●	●		3.0-10.0	0.5-2.0	57
HTZSB.	2-Flute Coated	●	●	●	●				3.0-10.0	0.5-2.0	58
HTZFN.	2-Flute Reduced Neck	●	●	●	●	●	●		3.0-10.0	0.5-2.0	59
HTDAN.	3-Flute Stepped	●	●	●	●	●	●		8.0-20.0	0.5	61



• BE FAST. BE FIRST. BE FIRSTATTEC •

TORUSFRÄSER

1-SCHNEIDER TORIC END MILL 1-FLUTE

Multitalent in der HSC-Zerspanung.
Fräswerkzeug mit definiertem Eckenradius,
z.B. für Freiformflächen.

Multitalent in High-Speed Machining.
Milling tool with defined corner radius,
e.g. for contour surfaces.

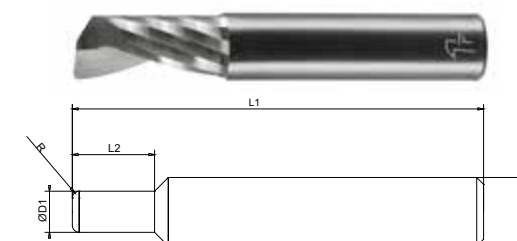

ALU
ALUMINIUM

ALU
ELOXIERT
ANODIZED
ALU

KUNST
STOFF
PLASTIC

UNSERE EXPERTEN
FÜR IHREN ERFOLG.
OUR EXPERTS FOR YOUR SUCCESS.

ART.-NR. ARTICLE-CODE	GEWINDE THREAD	D1 (h9)	D2 (h6)	D3	L1	L2	L3	R	α	PREIS PRICE
		(mm)	(mm)							(mm)
HTESN.										
030.03.055.050		3.0	3.0		40.0	5.5		0.5		17,00 €
030.06.065.050		3.0	6.0		50.0	6.5		0.5		23,00 €
040.06.085.050		4.0	6.0		50.0	8.5		0.5		25,00 €
040.06.085.100		4.0	6.0		50.0	8.5		1.0		26,00 €
050.06.105.050		5.0	6.0		50.0	10.5		0.5		25,00 €
050.06.105.100		5.0	6.0		50.0	10.5		1.0		26,00 €
060.06.125.050		6.0	6.0		50.0	12.5		0.5		25,00 €
060.06.125.100		6.0	6.0		50.0	12.5		1.0		26,00 €
060.06.205.050		6.0	6.0		60.0	20.5		0.5		28,00 €
060.06.205.100		6.0	6.0		60.0	20.5		1.0		29,00 €
080.08.165.100		8.0	8.0		50.0	16.5		1.0		32,00 €
080.08.165.200		8.0	8.0		50.0	16.5		2.0		33,00 €
100.10.205.100		10.0	10.0		60.0	20.5		1.0		40,00 €
100.10.205.200		10.0	10.0		60.0	20.5		2.0		41,00 €

-5%	-10%	-20%
> 5 STK.	> 10 STK.	> 20 STK.
> 5 PCS.	> 10 PCS.	> 20 PCS.



FIRSTATTEC

FIRSTATTEC GMBH | CARL-BENZ-STR. 5 | 68723 SCHWETZINGEN
☎ 0 8000 150 250 | CONTACT@FIRSTATTEC.DE ☏
• WWW.FIRSTATTEC.DE •

SCHAFTFRÄSER
TORUSFRÄSER
VOLLRADIUSFRÄSER
ENTGRATWERKZEUGE
GRAVIERWERKZEUGE
GEWINDEWERKZEUGE
BOHRWERKZEUGE
SPEZIALWERKZEUGE



TORUSFRÄSER

1-SCHNEIDER, BESCHICHTET TORIC END MILL 1-FLUTE, COATED

Multitalent in der HSC-Zerspanung. Fräs Werkzeug mit definiertem Eckenradius, z.B. für Freiformflächen. Modernste Beschichtungstechnologie für längere Standzeiten.

Multitalent in High-Speed Machining. Milling tool with defined corner radius, e.g. for contour surfaces. Cutting edge coating technology for longer tool life.

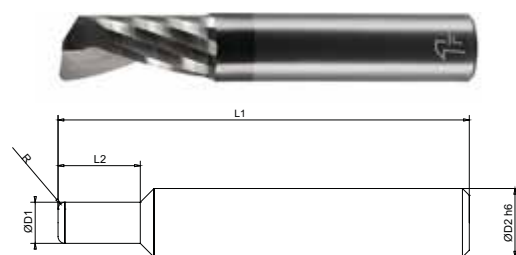

- ALU ALUMINIUM
- ALU ELOXIERT ANODIZED ALU

ART.-NR. ARTICLE-CODE	GEWINDE THREAD	D1 (h9)	D2 (h6)	D3	L1	L2	L3	R	α	PREIS PRICE
		(mm)	(mm)							(mm)
HTESB.										
B01.030.03.055.050		3.0	3.0		40.0	5.5		0.5		23,00 €
B01.030.06.065.050		3.0	6.0		50.0	6.5		0.5		32,00 €
B01.040.06.085.050		4.0	6.0		50.0	8.5		0.5		34,00 €
B01.040.06.085.100		4.0	6.0		50.0	8.5		1.0		35,00 €
B01.050.06.105.050		5.0	6.0		50.0	10.5		0.5		34,00 €
B01.050.06.105.100		5.0	6.0		50.0	10.5		1.0		35,00 €
B01.060.06.125.050		6.0	6.0		50.0	12.5		0.5		34,00 €
B01.060.06.125.100		6.0	6.0		50.0	12.5		1.0		35,00 €
B01.060.06.205.050		6.0	6.0		60.0	20.5		0.5		37,00 €
B01.060.06.205.100		6.0	6.0		60.0	20.5		1.0		38,00 €
B01.080.08.165.100		8.0	8.0		50.0	16.5		1.0		44,00 €
B01.080.08.165.200		8.0	8.0		50.0	16.5		2.0		45,00 €
B01.100.10.205.100		10.0	10.0		60.0	20.5		1.0		56,00 €
B01.100.10.205.200		10.0	10.0		60.0	20.5		2.0		57,00 €

- 5% > 5 STK. | > 5 PCS.
- 10% > 10 STK. | > 10 PCS.
- 20% > 20 STK. | > 20 PCS.

FIRSTATTEC



TORUSFRÄSER

1-SCHNEIDER, FREISCHLIFF TORIC END MILL 1-FLUTE, REDUCED NECK

Multitalent in der HSC-Zerspanung. Fräs Werkzeug mit definiertem Eckenradius, z.B. für Freiformflächen. Geeignet für die Tiefenbearbeitung.

Multitalent in High-Speed Machining. Milling tool with defined corner radius, e.g. for contour surfaces. Milling tool for cutting foam in depth machining.

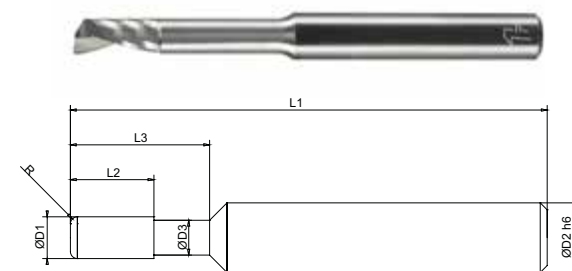

- ALU ALUMINIUM
- ALU ELOXIERT ANODIZED ALU
- KUNSTSTOFF PLASTIC

ART.-NR. ARTICLE-CODE	GEWINDE THREAD	D1 (h9)	D2 (h6)	D3	L1	L2	L3	R	α	PREIS PRICE
		(mm)	(mm)							(mm)
HTEFN.										
030.03.055.130.050		3.0	3.0	2.8	50.0	5.5	13.0	0.5		22,00 €
030.06.065.180.050		3.0	6.0	2.8	60.0	6.5	18.0	0.5		29,00 €
040.06.085.210.050		4.0	6.0	3.7	60.0	8.5	21.0	0.5		31,00 €
040.06.085.210.100		4.0	6.0	3.7	60.0	8.5	21.0	1.0		32,00 €
050.06.105.260.050		5.0	6.0	4.6	60.0	10.5	26.0	0.5		31,00 €
050.06.105.260.100		5.0	6.0	4.6	60.0	10.5	26.0	1.0		32,00 €
060.06.125.310.050		6.0	6.0	5.5	70.0	12.5	31.0	0.5		32,00 €
060.06.125.310.100		6.0	6.0	5.5	70.0	12.5	31.0	1.0		33,00 €
080.08.165.410.100		8.0	8.0	7.5	80.0	16.5	41.0	1.0		41,00 €
080.08.165.410.200		8.0	8.0	7.5	80.0	16.5	41.0	2.0		42,00 €
100.10.205.510.100		10.0	10.0	9.5	90.0	20.5	51.0	1.0		51,00 €
100.10.205.510.200		10.0	10.0	9.5	90.0	20.5	51.0	2.0		52,00 €

- 5% > 5 STK. | > 5 PCS.
- 10% > 10 STK. | > 10 PCS.
- 20% > 20 STK. | > 20 PCS.

FIRSTATTEC



TORUSFRÄSER

2-SCHNEIDER TORIC END MILL 2-FLUTE

Universal Fräs Werkzeug zur Zerspannung von NE-Metallen. Fräs Werkzeug mit definiertem Eckenradius.

Universal milling tool for cutting non-ferrous metals with defined corner radius.

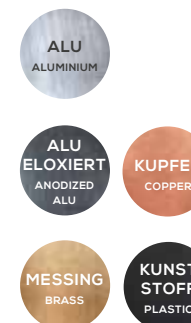
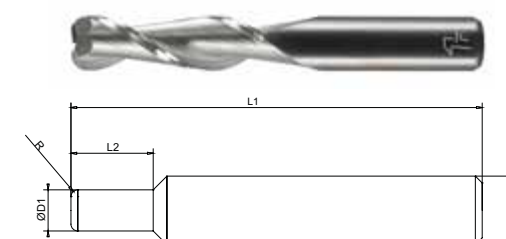

ART.-NR. ARTICLE-CODE	GEWINDE THREAD	D1 (h9)	D2 (h6)	D3	L1	L2	L3	R	α	PREIS PRICE
		(mm)	(mm)	(mm)	(mm)	(mm)	(mm)	(mm)		€/STK. €/PC.
HTZSN.										
030.03.065.050		3.0	3.0		40.0	6.5		0.5		17,00 €
030.06.095.050		3.0	6.0		50.0	9.5		0.5		24,00 €
040.06.125.050		4.0	6.0		50.0	12.5		0.5		26,00 €
040.06.125.100		4.0	6.0		50.0	12.5		1.0		27,00 €
050.06.155.050		5.0	6.0		50.0	15.5		0.5		26,00 €
050.06.155.100		5.0	6.0		50.0	15.5		1.0		27,00 €
060.06.185.050		6.0	6.0		50.0	18.5		0.5		26,00 €
060.06.185.100		6.0	6.0		50.0	18.5		1.0		27,00 €
080.08.265.100		8.0	8.0		60.0	26.5		1.0		36,00 €
080.08.265.200		8.0	8.0		60.0	26.5		2.0		37,00 €
100.10.305.100		10.0	10.0		70.0	30.5		1.0		45,00 €
100.10.305.200		10.0	10.0		70.0	30.5		2.0		46,00 €

-5%	-10%	-20%
> 5 STK.	> 10 STK.	> 20 STK.
> 5 PCS.	> 10 PCS.	> 20 PCS.

FIRSTATTEC

SCHAFTFRÄSER
TORUSFRÄSER
VOLLRADIUSFRÄSER
ENTGRATWERKZEUGE
GRAVIERWERKZEUGE
GEWINDEWERKZEUGE
BOHRWERKZEUGE
SPEZIALWERKZEUGE



TORUSFRÄSER

2-SCHNEIDER, BESCHICHTET TORIC END MILL 2-FLUTE, COATED

Universal Fräs Werkzeug zur Zerspaltung von NE-Metallen. Definierter Eckenradius und modernste Beschichtungstechnologie für längere Standzeiten.

Universal milling tool for cutting non-ferrous metals. Defined corner radius and cutting edge coating technology for longer tool life.

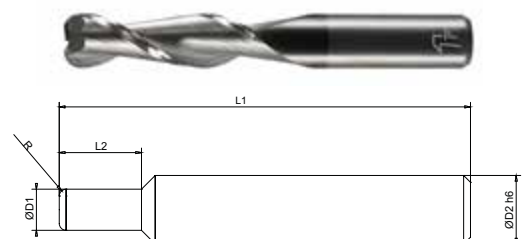

ART.-NR. ARTICLE-CODE	GEWINDE THREAD	D1 (h9)	D2 (h6)	D3	L1	L2	L3	R	α	PREIS PRICE
		(mm)	(mm)	(mm)	(mm)	(mm)	(mm)	(mm)		€/STK. €/PC.
HTZSB.										
B01.030.03.065.050		3.0	3.0		40.0	6.5		0.5		23,00 €
B01.030.06.095.050		3.0	6.0		50.0	9.5		0.5		33,00 €
B01.040.06.125.050		4.0	6.0		50.0	12.5		0.5		35,00 €
B01.040.06.125.100		4.0	6.0		50.0	12.5		1.0		36,00 €
B01.050.06.155.050		5.0	6.0		50.0	15.5		0.5		35,00 €
B01.050.06.155.100		5.0	6.0		50.0	15.5		1.0		36,00 €
B01.060.06.185.050		6.0	6.0		50.0	18.5		0.5		35,00 €
B01.060.06.185.100		6.0	6.0		50.0	18.5		1.0		36,00 €
B01.080.08.265.100		8.0	8.0		60.0	26.5		1.0		48,00 €
B01.080.08.265.200		8.0	8.0		60.0	26.5		2.0		49,00 €
B01.100.10.305.100		10.0	10.0		70.0	30.5		1.0		61,00 €
B01.100.10.305.200		10.0	10.0		70.0	30.5		2.0		62,00 €

-5% > 5 STK. > 5 PCS. | -10% > 10 STK. > 10 PCS. | -20% > 20 STK. > 20 PCS.

FIRSTATTEC



TORUSFRÄSER

2-SCHNEIDER, FREISCHLIFF TORIC END MILL 2-FLUTE, REDUCED NECK

Universal Fräs Werkzeug zur Zerspaltung von NE-Metallen. Fräs Werkzeug mit definiertem Eckenradius. Geeignet für die Tiefenbearbeitung.

Universal milling tool for cutting non-ferrous metals with defined corner radius in depth machining.

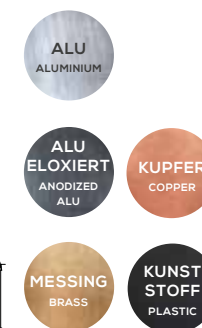
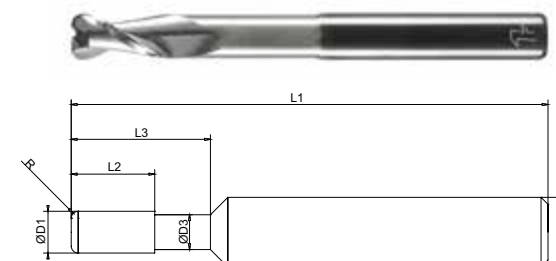

ART.-NR. ARTICLE-CODE	GEWINDE THREAD	D1 (h9)	D2 (h6)	D3	L1	L2	L3	R	α	PREIS PRICE
		(mm)	(mm)	(mm)	(mm)	(mm)	(mm)	(mm)		€/STK. €/PC.
HTZFN.										
030.03.065.130.050		3.0	3.0	2.8	50.0	6.5	13.0	0.5		22,00 €
030.06.095.180.050		3.0	6.0	2.8	60.0	9.5	18.0	0.5		30,00 €
040.06.085.210.050		4.0	6.0	3.7	60.0	8.5	21.0	0.5		31,00 €
040.06.085.210.100		4.0	6.0	3.7	60.0	8.5	21.0	1.0		32,00 €
050.06.105.260.050		5.0	6.0	4.6	60.0	10.5	26.0	0.5		31,00 €
050.06.105.260.100		5.0	6.0	4.6	60.0	10.5	26.0	1.0		32,00 €
060.06.125.310.050		6.0	6.0	5.5	70.0	12.5	31.0	0.5		32,00 €
060.06.125.310.100		6.0	6.0	5.5	70.0	12.5	31.0	1.0		33,00 €
080.08.165.410.100		8.0	8.0	7.5	80.0	16.5	41.0	1.0		41,00 €
080.08.165.410.200		8.0	8.0	7.5	80.0	16.5	41.0	2.0		42,00 €
100.10.205.510.100		10.0	10.0	9.5	90.0	20.5	51.0	1.0		51,00 €
100.10.205.510.200		10.0	10.0	9.5	90.0	20.5	51.0	2.0		52,00 €

-5% > 5 STK. > 5 PCS. | -10% > 10 STK. > 10 PCS. | -20% > 20 STK. > 20 PCS.

FIRSTATTEC



TORUSFRÄSER

3-SCHNEIDER, ABGESTUFT TORIC END MILL 3-FLUTE, STEPPED

Fräs Werkzeug zur Zerspaltung von NE-Metallen. Großer Fräsdurchmesser zum Überfräsen großer Oberflächen mit definiertem Eckenradius.

Milling tool for cutting non-ferrous metals. Large milling diameter for milling large surfaces with defined corner radius.

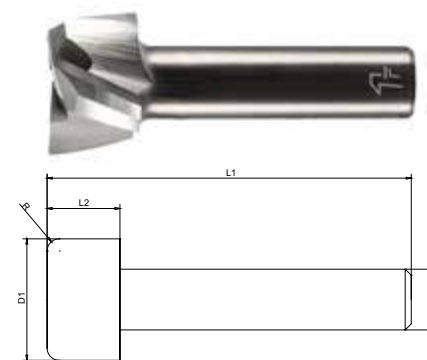

ART.-NR. ARTICLE-CODE	GEWINDE THREAD	D1 (h9)	D2 (h6)	D3	L1	L2	L3	R	α	PREIS PRICE
		(mm)	(mm)	(mm)	(mm)	(mm)	(mm)	(mm)		€/STK. €/PC.
HTDAN.										
080.06.080.050		8.0	6.0		50.0	8.0		0.5		48,00 €
100.06.080.050		10.0	6.0		50.0	8.0		0.5		65,00 €
100.08.100.050		10.0	8.0		50.0	10.0		0.5		65,00 €
120.06.080.050		12.0	6.0		50.0	8.0		0.5		85,00 €
120.08.100.050		12.0	8.0		50.0	10.0		0.5		85,00 €
120.10.120.050		12.0	10.0		50.0	12.0		0.5		85,00 €
140.08.100.050		14.0	8.0		50.0	10.0		0.5		110,00 €
140.10.120.050		14.0	10.0		50.0	12.0		0.5		110,00 €
200.10.120.050		20.0	10.0		50.0	12.0		0.5		148,00 €

-5%	-10%	-20%
> 5 STK.	> 10 STK.	> 20 STK.
> 5 PCS.	> 10 PCS.	> 20 PCS.

FIRSTATTEC



HSC-VOLLRADIUSFRÄSER		ALUMINIUM	ALUMINIUM ELOXIERT	MESSING	KUPFER	KUNSTSTOFF	ACRYL	SCHAUMSTOFF	VORAUSWAHL		
									(MM)	(MM)	(KATALOG)
									D1	D2	SEITE
HVESN.	1-Schneider	●	●	●	●	●	●		1.0-10.0	3.0-10.0	65
HVESB.	1-Schneider Beschichtet	●	●	●	●	●	●		1.0-10.0	3.0-10.0	66
HVEZN.	1-Schneider 1/8" Schaft	●	●	●	●	●	●		1.0-3.175	3.175	67
HVEFN.	1-Schneider Freischliff	●	●	●	●	●	●		1.0-10.0	3.0-10.0	68
HVEPN.	1-Schneider Poliert							●	1.0-10.0	3.0-10.0	69
HVZSN.	2-Schneider	●	●	●	●	●	●		0.5-10.0	3.0-10.0	71
HVZSB.	2-Schneider Beschichtet	●	●	●	●	●	●		0.5-10.0	3.0-10.0	72
HVZZN.	2-Schneider 1/8" Schaft	●	●	●	●	●	●		0.5-3.175	3.175	73
HVZFN.	2-Schneider Freischliff	●	●	●	●	●	●		0.5-10.0	3.0-10.0	75
HVDSN.	3-Schneider	●	●	●	●	●	●		1.0-10.0	3.0-10.0	77
HVDSB.	3-Schneider Beschichtet	●	●	●	●	●	●		1.0-10.0	3.0-10.0	78
HVDFN.	3-Schneider Freischliff	●	●	●	●	●	●		1.0-10.0	3.0-10.0	79
HVDWN.	3-Schneider Schaumstoff							●	3.0-10.0	3.0-10.0	80
HVDWF.	3-Schneider Freischliff Schaumstoff							●	3.0-10.0	6.0-10.0	81

HSC-BALL END MILL		ALUMINIUM	ALUMINIUM ANODIZED	BRASS	COPPER	PLASTIC	ACRYLIC	FOAM	PRESELECTION		
									(MM)	(MM)	(KATALOG)
									D1	D2	PAGE
HVESN.	1-Flute	●	●	●	●	●	●		1.0-10.0	3.0-10.0	65
HVESB.	1-Flute Coated	●	●	●	●	●	●		1.0-10.0	3.0-10.0	66
HVEZN.	1-Flute 1/8" Shank	●	●	●	●	●	●		1.0-3.175	3.175	67
HVEFN.	1-Flute Reduced Neck	●	●	●	●	●	●		1.0-10.0	3.0-10.0	68
HVEPN.	1-Flute Polished					●	●		1.0-10.0	3.0-10.0	69
HVZSN.	2-Flute	●	●	●	●	●	●		0.5-10.0	3.0-10.0	71
HVZSB.	2-Flute Coated	●	●	●	●	●	●		0.5-10.0	3.0-10.0	72
HVZZN.	2-Flute 1/8" Shank	●	●	●	●	●	●		0.5-3.175	3.175	73
HVZFN.	2-Flute Reduced Neck	●	●	●	●	●	●		0.5-10.0	3.0-10.0	75
HVDSN.	3-Flute	●	●	●	●	●	●		1.0-10.0	3.0-10.0	77
HVDSB.	3-Flute Coated	●	●	●	●	●	●		1.0-10.0	3.0-10.0	78
HVDFN.	3-Flute Reduced Neck	●	●	●	●	●	●		1.0-10.0	3.0-10.0	79
HVDWN.	3-Flute Foam							●	3.0-10.0	3.0-10.0	80
HVDWF.	3-Flute Reduced Neck Foam							●	3.0-10.0	6.0-10.0	81



• BE FAST. BE FIRST. BE FIRSTATTEC •

VOLLRADIUSFRÄSER

1-SCHNEIDER BALL END MILL 1-FLUTE

Multitalent in der HSC-Zerspanung.
Stirnradius-Fräswerkzeug, z.B. für die
3-D Bearbeitung.

Multitalent in High-Speed Machining.
Ball end mill, e.g. for 3-D machining.

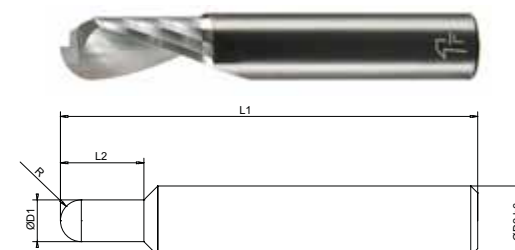

ALU
ALUMINIUM

ALU
ELOXIERT
ANODIZED
ALU

KUNST
STOFF
PLASTIC

DIE KRAFT AUS ERFAHRUNG
UND LEIDENSCHAFT.
THE POWER OF PASSION AND PRACTICE.

ART.-NR. ARTICLE-CODE	GEWINDE THREAD	D1 (h9)	D2 (h6)	D3	L1	L2	L3	R	α	PREIS PRICE
		(mm)	(mm)	(mm)	(mm)	(mm)	(mm)	(mm)		€/STK. €/PC.
HVESN.										
010.03.025		1.0	3.0		40.0	2.5		0.5		21,00 €
010.03.045		1.0	3.0		40.0	4.5		0.5		23,00 €
020.03.025		2.0	3.0		40.0	2.5		1.0		20,00 €
020.03.055		2.0	3.0		40.0	5.5		1.0		21,00 €
020.06.070		2.0	6.0		50.0	7.0		1.0		27,00 €
030.03.035		3.0	3.0		40.0	3.5		1.5		20,00 €
030.06.065		3.0	6.0		50.0	6.5		1.5		27,00 €
040.06.085		4.0	6.0		50.0	8.5		2.0		29,00 €
050.06.105		5.0	6.0		50.0	10.5		2.5		29,00 €
060.06.065		6.0	6.0		50.0	6.5		3.0		28,00 €
060.06.125		6.0	6.0		50.0	12.5		3.0		29,00 €
080.08.165		8.0	8.0		50.0	16.5		4.0		35,00 €
100.10.205		10.0	10.0		60.0	20.5		5.0		44,00 €

-5%	-10%	-20%
> 5 STK.	> 10 STK.	> 20 STK.
> 5 PCS.	> 10 PCS.	> 20 PCS.



FIRSTATTEC

FIRSTATTEC GMBH | CARL-BENZ-STR. 5 | 68723 SCHWETZINGEN
☎ 0 8000 150 250 | CONTACT@FIRSTATTEC.DE ☏
• WWW.FIRSTATTEC.DE •



VOLLRADIUSFRÄSER

1-SCHNEIDER, BESCHICHTET BALL END MILL 1-FLUTE, COATED

Multitalent in der HSC-Zerspanung.
Stirnradius-Fräswerkzeug, z.B. für die 3-D
Bearbeitung. Modernste Beschichtungs-
technologie für längere Standzeiten.

Multitalent in High-Speed Machining.
Ball end mill, e.g. for 3-D machining. Cutting
edge coating technology for longer tool life.

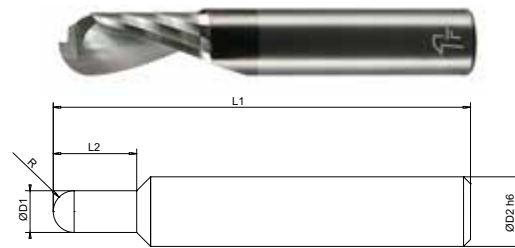

ART.-NR. ARTICLE-CODE	GEWINDE THREAD	D1 (h9)	D2 (h6)	D3	L1	L2	L3	R	α	PREIS PRICE
		(mm)	(mm)	(mm)	(mm)	(mm)	(mm)	(mm)		€/STK. €/PC.
HVESB.										
B01.010.03.025		1.0	3.0	40.0	2.5			0.5		27,00 €
B01.010.03.045		1.0	3.0	40.0	4.5			0.5		29,00 €
B01.020.03.025		2.0	3.0	40.0	2.5			1.0		26,00 €
B01.020.03.055		2.0	3.0	40.0	5.5			1.0		27,00 €
B01.030.03.035		3.0	3.0	40.0	3.5			1.5		26,00 €
B01.030.06.065		3.0	6.0	50.0	6.5			1.5		36,00 €
B01.040.06.085		4.0	6.0	50.0	8.5			2.0		38,00 €
B01.050.06.105		5.0	6.0	50.0	10.5			2.5		38,00 €
B01.060.06.065		6.0	6.0	50.0	6.5			3.0		37,00 €
B01.060.06.125		6.0	6.0	50.0	12.5			3.0		38,00 €
B01.080.08.165		8.0	8.0	50.0	16.5			4.0		47,00 €
B01.100.10.205		10.0	10.0	60.0	20.5			5.0		60,00 €

-5%	-10%	-20%
> 5 STK.	> 10 STK.	> 20 STK.
> 5 PCS.	> 10 PCS.	> 20 PCS.

FIRSTATTEC



VOLLRADIUSFRÄSER

1-SCHNEIDER, 1/8" SCHAFT BALL END MILL 1-FLUTE, 1/8" SHANK

Multitalent in der HSC-Zerspanung.
Stirnradius-Fräswerkzeug,
z.B. für die 3-D Bearbeitung.

Multitalent in High-Speed Machining.
Ball end mill, e.g. for 3-D machining.

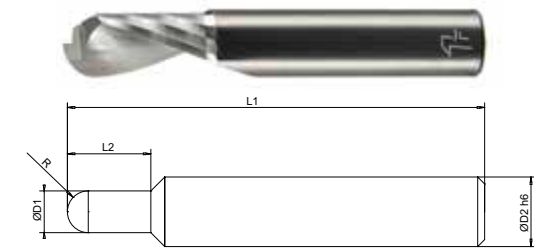

ART.-NR. ARTICLE-CODE	GEWINDE THREAD	D1 (h9)	D2 (h6)	D3	L1	L2	L3	R	α	PREIS PRICE
		(mm)	(mm)	(mm)	(mm)	(mm)	(mm)	(mm)		€/STK. €/PC.
HVEZN.										
010.18.025		1.0	3.175	40.0	2.5			0.5		20,00 €
010.18.045		1.0	3.175	40.0	4.5			0.5		22,00 €
020.18.025		2.0	3.175	40.0	2.5			1.0		19,00 €
020.18.055		2.0	3.175	40.0	5.5			1.0		20,00 €
030.18.035		3.0	3.175	40.0	3.5			1.5		19,00 €
030.18.065		3.0	3.175	40.0	6.5			1.5		20,00 €
180.18.065		3.175	3.175	40.0	6.5			1.587		20,00 €

-5%	-10%	-20%
> 5 STK.	> 10 STK.	> 20 STK.
> 5 PCS.	> 10 PCS.	> 20 PCS.

FIRSTATTEC

SCHAFTFRÄSER
TORUSFRÄSER
VOLLRADIUSFRÄSER
ENTGRATWERKZEUGE
GRAVIERWERKZEUGE
GEWINDEWERKZEUGE
BOHRWERKZEUGE
SPEZIALWERKZEUGE



VOLLRADIUSFRÄSER

1-SCHNEIDER, FREISCHLIFF BALL END MILL 1-FLUTE, REDUCED NECK

Multitalent in der HSC-Zerspanung.
Stirnradius-Fräswerkzeug, z.B. für die 3-D
Bearbeitung mit hoher Bearbeitungstiefe.

Multitalent in High-Speed Machining.
Ball end mill, e.g. for 3-D machining in
depth machining.

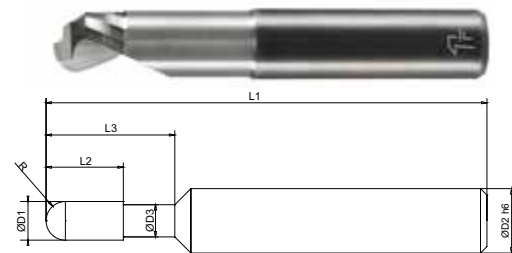

ALU
ALUMINIUM

ALU
ELOXIERT
ANODIZED
ALU

KUNST
STOFF
PLASTIC

ART.-NR. ARTICLE-CODE	GEWINDE THREAD	D1 (h9)	D2 (h6)	D3	L1	L2	L3	R	α	PREIS PRICE
		(mm)	(mm)							(mm)
HVEFN.										
010.03.025.070		1.0	3.0	0.9	40.0	2.5	7.0	0.5		27,00 €
020.03.025.110		2.0	3.0	1.8	50.0	2.5	11.0	1.0		25,00 €
030.03.035.130		3.0	3.0	2.8	50.0	3.5	13.0	1.5		25,00 €
030.06.035.160		3.0	6.0	2.8	50.0	3.5	16.0	1.5		32,00 €
040.06.045.180		4.0	6.0	3.7	60.0	4.5	18.0	2.0		33,00 €
050.06.055.210		5.0	6.0	4.6	60.0	5.5	21.0	2.5		33,00 €
060.06.065.210		6.0	6.0	5.5	60.0	6.5	21.0	3.0		31,00 €
060.06.065.260		6.0	6.0	5.5	60.0	6.5	26.0	3.0		32,00 €
080.08.085.260		8.0	8.0	7.5	60.0	8.5	26.0	4.0		40,00 €
100.10.105.310		10.0	10.0	9.5	70.0	10.5	31.0	5.0		51,00 €

-5% > 5 STK. > 5 PCS. | -10% > 10 STK. > 10 PCS. | -20% > 20 STK. > 20 PCS.

FIRSTATTEC



VOLLRADIUSFRÄSER

1-SCHNEIDER, POLIERT BALL END MILL 1-FLUTE, POLISHED

Multitalent in der HSC-Zerspanung.
Stirnradius-Fräswerkzeug, z.B. für die 3-D
Bearbeitung von Kunststoffen und Acryl
mit hoher Oberflächengüte.

Multitalent in High-Speed Machining.
Ball end mill, e.g. for 3-D machining of
plastics and acrylic with high surface quality.

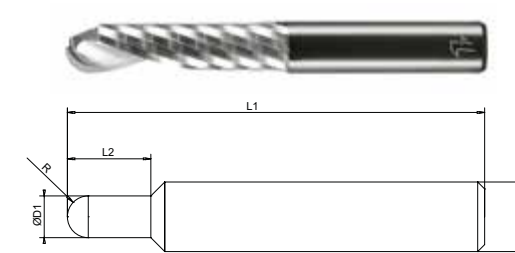

KUNST
STOFF
PLASTIC

ACRYL
ACRYLIC

ART.-NR. ARTICLE-CODE	GEWINDE THREAD	D1 (h9)	D2 (h6)	D3	L1	L2	L3	R	α	PREIS PRICE
		(mm)	(mm)							(mm)
HVEPN.										
010.03.045		1.0	3.0		40.0	4.5		0.5		29,00 €
020.03.085		2.0	3.0		40.0	8.5		1.0		29,00 €
030.03.095		3.0	3.0		40.0	9.5		1.5		28,00 €
030.06.125		3.0	6.0		50.0	12.5		1.5		36,00 €
040.06.165		4.0	6.0		50.0	16.5		2.0		38,00 €
050.06.205		5.0	6.0		60.0	20.5		2.5		38,00 €
060.06.185		6.0	6.0		50.0	18.5		3.0		39,00 €
060.06.265		6.0	6.0		60.0	26.5		3.0		40,00 €
080.08.325		8.0	8.0		70.0	32.5		4.0		52,00 €
100.10.405		10.0	10.0		80.0	40.5		5.0		64,00 €

-5% > 5 STK. > 5 PCS. | -10% > 10 STK. > 10 PCS. | -20% > 20 STK. > 20 PCS.

FIRSTATTEC

SCHAFTFRÄSER
TORUSFRÄSER
VOLLRADIUSFRÄSER
ENTGRATWERKZEUGE
GRAVIERWERKZEUGE
GEWINDEWERKZEUGE
BOHRWERKZEUGE
SPEZIALWERKZEUGE

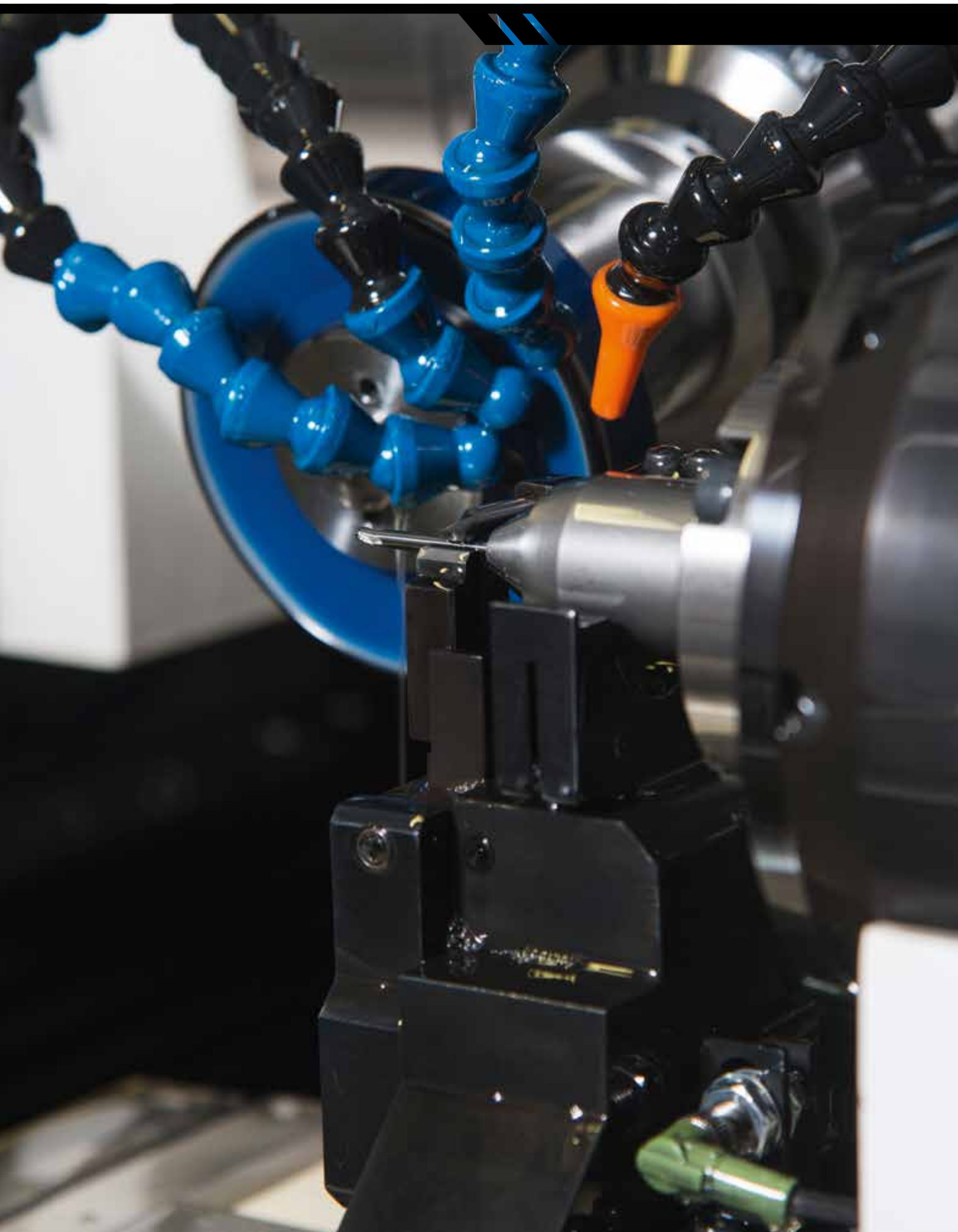

VOLLRADIUSFRÄSER

2-SCHNEIDER BALL END MILL 2-FLUTE

Universal Stirnradius-Fräswerkzeug zur Zerspaltung von NE-Metallen, z.B. für die 3-D Bearbeitung.

Universal ball end mill for cutting non-ferrous metals, e.g. for 3-D machining.

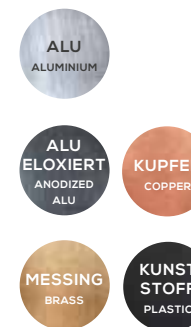
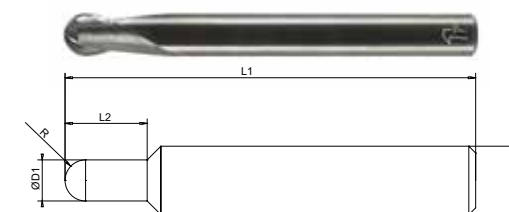

ART.-NR. ARTICLE-CODE	GEWINDE THREAD	D1 (h9)	D2 (h6)	D3	L1	L2	L3	R	α	PREIS PRICE
		(mm)	(mm)	(mm)	(mm)	(mm)	(mm)	(mm)		€/STK. €/PC.
HVZSN.										
005.03.015		0.5	3.0		40.0	1.5		0.25		25,00 €
010.03.025		1.0	3.0		40.0	2.5		0.5		21,00 €
015.03.035		1.5	3.0		40.0	3.5		0.75		21,00 €
020.03.045		2.0	3.0		40.0	4.5		1.0		21,00 €
030.03.035		3.0	3.0		40.0	3.5		1.5		20,00 €
030.06.065		3.0	6.0		50.0	6.5		1.5		27,00 €
040.06.085		4.0	6.0		50.0	8.5		2.0		29,00 €
050.06.105		5.0	6.0		50.0	10.5		2.5		29,00 €
060.06.065		6.0	6.0		50.0	6.5		3.0		28,00 €
060.06.125		6.0	6.0		50.0	12.5		3.0		29,00 €
080.08.165		8.0	8.0		50.0	16.5		4.0		35,00 €
100.10.205		10.0	10.0		60.0	20.5		5.0		44,00 €

-5%	-10%	-20%
> 5 STK.	> 10 STK.	> 20 STK.
> 5 PCS.	> 10 PCS.	> 20 PCS.

FIRSTATTEC



VOLLRADIUSFRÄSER

2-SCHNEIDER, BESCHICHTET BALL END MILL 2-FLUTE, COATED

Universal Stirnradius-Fräswerkzeug zur Zerspanung von NE-Metallen, z.B. für die 3-D Bearbeitung. Modernste Beschichtungstechnologie für längere Standzeiten.

Universal ball end mill for cutting non-ferrous metals, e.g. for 3-D machining. Cutting edge coating technology for longer tool life.

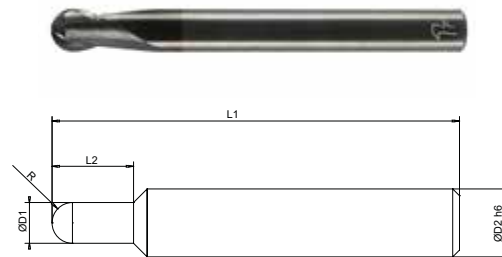

ART.-NR. ARTICLE-CODE	GEWINDE THREAD	D1 (h9) (mm)	D2 (h6) (mm)	D3 (mm)	L1 (mm)	L2 (mm)	L3 (mm)	R (mm)	α	PREIS PRICE
										€/STK. €/PC.
HVZSB.										
B01.005.03.015		0.5	3.0		40.0	1.5		0.25		31,00 €
B01.010.03.025		1.0	3.0		40.0	2.5		0.5		27,00 €
B01.015.03.035		1.5	3.0		40.0	3.5		0.75		27,00 €
B01.020.03.045		2.0	3.0		40.0	4.5		1.0		27,00 €
B01.030.03.035		3.0	3.0		40.0	3.5		1.5		26,00 €
B01.030.06.065		3.0	6.0		50.0	6.5		1.5		36,00 €
B01.040.06.085		4.0	6.0		50.0	8.5		2.0		38,00 €
B01.050.06.105		5.0	6.0		50.0	10.5		2.5		38,00 €
B01.060.06.065		6.0	6.0		50.0	6.5		3.0		37,00 €
B01.060.06.125		6.0	6.0		50.0	12.5		3.0		38,00 €
B01.080.08.165		8.0	8.0		50.0	16.5		4.0		47,00 €
B01.100.10.205		10.0	10.0		60.0	20.5		5.0		60,00 €

-5% > 5 STK. | -10% > 10 STK. | -20% > 20 STK.
 > 5 PCS. | > 10 PCS. | > 20 PCS.

FIRSTATTEC



VOLLRADIUSFRÄSER

2-SCHNEIDER, 1/8" SCHAFT BALL END MILL 2-FLUTE, 1/8" SHANK

Universal Stirnradius-Fräswerkzeug zur Zerspanung von NE-Metallen, z.B. für die 3-D Bearbeitung.

Universal ball end mill for cutting non-ferrous metals, e.g. for 3-D machining.

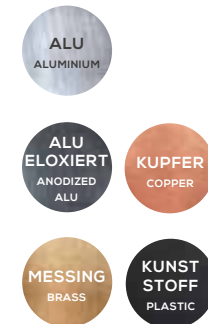
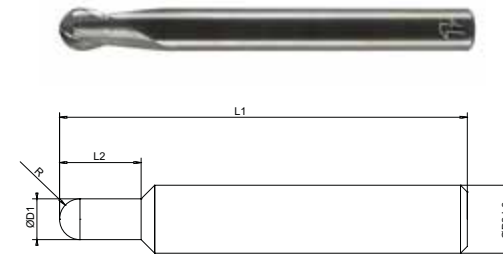

ART.-NR. ARTICLE-CODE	GEWINDE THREAD	D1 (h9) (mm)	D2 (h6) (mm)	D3 (mm)	L1 (mm)	L2 (mm)	L3 (mm)	R (mm)	α	PREIS PRICE
										€/STK. €/PC.
HVZZN.										
005.18.015		0.5	3.175		40.0	1.5		0.25		24,00 €
010.18.025		1.0	3.175		40.0	2.5		0.5		20,00 €
015.18.035		1.5	3.175		40.0	3.5		0.75		20,00 €
020.18.045		2.0	3.175		40.0	4.5		1.0		20,00 €
030.18.035		3.0	3.175		40.0	3.5		1.5		19,00 €
030.18.065		3.0	3.175		40.0	6.5		1.5		20,00 €
180.18.065		3.175	3.175		40.0	6.5		1.587		20,00 €

-5% > 5 STK. | -10% > 10 STK. | -20% > 20 STK.
 > 5 PCS. | > 10 PCS. | > 20 PCS.

FIRSTATTEC

SCHAFTFRÄSER
TORUSFRÄSER
VOLLRADIUSFRÄSER
ENTGRATWERKZEUGE
GRAVIERWERKZEUGE
GEWINDEWERKZEUGE
BOHRWERKZEUGE
SPEZIALWERKZEUGE



DIGITALE QUALITÄTSSICHERUNG

VOLLRADIUSFRÄSER

2-SCHNEIDER, FREISCHLIFF
BALL END MILL 2-FLUTE, REDUCED NECK

Universal Stirnradius-Fräswerkzeug zur Zerspanung von NE-Metallen, z.B. für die 3-D Bearbeitung mit hoher Bearbeitungstiefe.

Universal ball end mill for cutting non-ferrous metals, e.g. for 3-D depth machining.

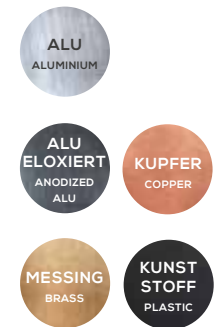
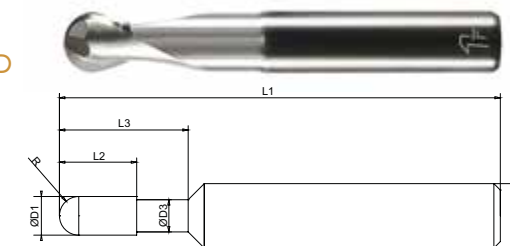

ART.-NR. ARTICLE-CODE	GEWINDE THREAD	D1 (h9)	D2 (h6)	D3	L1	L2	L3	R	α	PREIS PRICE
		(mm)	(mm)	(mm)	(mm)	(mm)	(mm)	(mm)		€/STK. €/PC.
HVZFN.										
005.03.015.050		0.5	3.0	0.4	40.0	1.5	5.0	0.25		33,00 €
010.03.025.070		1.0	3.0	0.9	40.0	2.5	7.0	0.5		27,00 €
015.03.035.110		1.5	3.0	1.4	50.0	3.5	11.0	0.75		27,00 €
020.03.045.110		2.0	3.0	1.8	50.0	4.5	11.0	1.0		26,00 €
030.03.035.130		3.0	3.0	2.8	50.0	3.5	13.0	1.5		25,00 €
030.06.065.160		3.0	6.0	2.8	50.0	6.5	16.0	1.5		33,00 €
040.06.085.180		4.0	6.0	3.7	60.0	8.5	18.0	2.0		34,00 €
050.06.105.210		5.0	6.0	4.6	60.0	10.5	21.0	2.5		34,00 €
060.06.065.210		6.0	6.0	5.5	60.0	6.5	21.0	3.0		32,00 €
060.06.125.260		6.0	6.0	5.5	60.0	12.5	26.0	3.0		34,00 €
080.08.085.260		8.0	8.0	7.5	60.0	8.5	26.0	4.0		40,00 €
100.10.105.310		10.0	10.0	9.5	70.0	10.5	31.0	5.0		51,00 €

-5%	-10%	-20%
> 5 STK.	> 10 STK.	> 20 STK.
> 5 PCS.	> 10 PCS.	> 20 PCS.

FIRSTATTEC

SCHAFTFRÄSER
TORUSFRÄSER
VOLLRADIUSFRÄSER
ENTGRATWERKZEUGE
GRAVIERWERKZEUGE
GEWINDEWERKZEUGE
BOHRWERKZEUGE
SPEZIALWERKZEUGE





TRU
TECH



VOLLRADIUSFRÄSER

3-SCHNEIDER BALL END MILL 3-FLUTE

Universal Stirnradius-Fräswerkzeug zur Zerspaltung von NE-Metallen, z.B. für die 3-D Bearbeitung. Schlichtfräser für hohe Oberflächengüte.

Universal ball end mill for cutting non-ferrous metals, e.g. for 3-D machining with high surface quality.

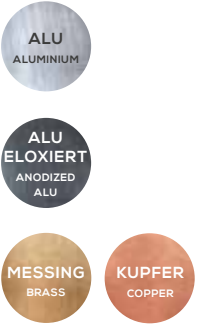
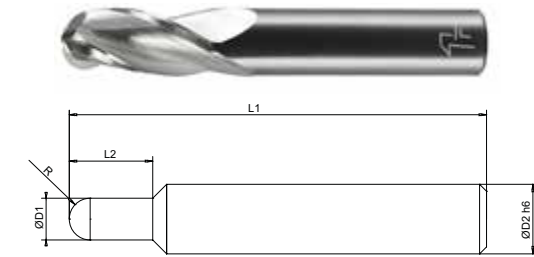

ART.-NR. ARTICLE-CODE	GEWINDE THREAD	D1 (h9)	D2 (h6)	D3	L1	L2	L3	R	α	PREIS PRICE
		(mm)	(mm)	(mm)	(mm)	(mm)	(mm)	(mm)		€/STK. €/PC.
HVDSN.										
010.03.025		1.0	3.0		40.0	2.5		0.5		23,00 €
020.03.045		2.0	3.0		40.0	4.5		1.0		23,00 €
030.03.035		3.0	3.0		40.0	3.5		1.5		22,00 €
030.06.065		3.0	6.0		50.0	6.5		1.5		29,00 €
040.06.085		4.0	6.0		50.0	8.5		2.0		31,00 €
050.06.105		5.0	6.0		50.0	10.5		2.5		31,00 €
060.06.065		6.0	6.0		50.0	6.5		3.0		30,00 €
060.06.125		6.0	6.0		50.0	12.5		3.0		31,00 €
080.08.165		8.0	8.0		50.0	16.5		4.0		37,00 €
100.10.205		10.0	10.0		60.0	20.5		5.0		46,00 €

-5%	-10%	-20%
> 5 STK.	> 10 STK.	> 20 STK.
> 5 PCS.	> 10 PCS.	> 20 PCS.

FIRSTATTEC

SCHAFTFRÄSER
TORUSFRÄSER
VOLLRADIUSFRÄSER
ENTGRATWERKZEUGE
GRAVIERWERKZEUGE
GEWINDEWERKZEUGE
BOHRWERKZEUGE
SPEZIALWERKZEUGE



VOLLRADIUSFRÄSER

3-SCHNEIDER, BESCHICHTET BALL END MILL 3-FLUTE, COATED

Universal Stirnradius-Fräswerkzeug zur Zerspaltung von NE-Metallen, z.B. für die 3-D Bearbeitung. Schlichtfräser für hohe Oberflächengüte kombiniert mit modernster Beschichtungstechnologie für längere Standzeiten.

Universal ball end mill for cutting non-ferrous metals, e.g. for 3-D machining with high surface quality. Cutting edge coating technology for longer tool life.

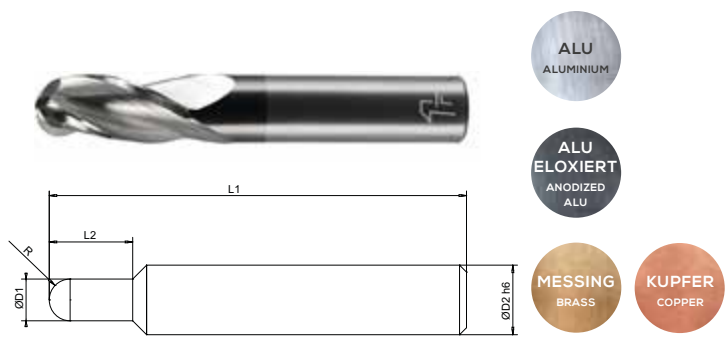

ART.-NR. ARTICLE-CODE	GEWINDE THREAD	D1 (h9)	D2 (h6)	D3	L1	L2	L3	R	α	PREIS PRICE
		(mm)	(mm)							(mm)
HVDSB.										
B01.010.03.025		1.0	3.0		40.0	2.5		0.5		29,00 €
B01.020.03.045		2.0	3.0		40.0	4.5		1.0		29,00 €
B01.030.03.035		3.0	3.0		40.0	3.5		1.5		28,00 €
B01.030.06.065		3.0	6.0		50.0	6.5		1.5		38,00 €
B01.040.06.085		4.0	6.0		50.0	8.5		2.0		40,00 €
B01.050.06.105		5.0	6.0		50.0	10.5		2.5		40,00 €
B01.060.06.065		6.0	6.0		50.0	6.5		3.0		39,00 €
B01.060.06.125		6.0	6.0		50.0	12.5		3.0		40,00 €
B01.080.08.165		8.0	8.0		50.0	16.5		4.0		49,00 €
B01.100.10.205		10.0	10.0		60.0	20.5		5.0		62,00 €

-5% > 5 STK. > 5 PCS. | -10% > 10 STK. > 10 PCS. | -20% > 20 STK. > 20 PCS.

FIRSTATTEC



VOLLRADIUSFRÄSER

3-SCHNEIDER, FREISCHLIFF BALL END MILL 3-FLUTE, REDUCED NECK

Universal Stirnradius-Fräswerkzeug zur Zerspaltung von NE-Metallen, z.B. für die 3-D Bearbeitung mit hoher Bearbeitungstiefe. Schlichtfräser für hohe Oberflächengüte.

Universal ball end mill for cutting non-ferrous metals, e.g. for 3-D depth machining with high surface quality.

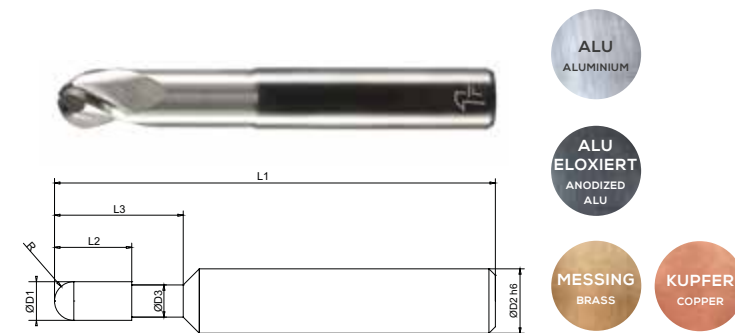

ART.-NR. ARTICLE-CODE	GEWINDE THREAD	D1 (h9)	D2 (h6)	D3	L1	L2	L3	R	α	PREIS PRICE
		(mm)	(mm)							(mm)
HVDFN										
010.03.025.070		1.0	3.0	0.9	40.0	2.5	7.0	0.5		29,00 €
020.03.045.110		2.0	3.0	1.8	50.0	4.5	11.0	1.0		28,00 €
030.03.035.130		3.0	3.0	2.8	50.0	3.5	13.0	1.5		27,00 €
030.06.065.160		3.0	6.0	2.8	50.0	6.5	16.0	1.5		35,00 €
040.06.085.180		4.0	6.0	3.7	60.0	8.5	18.0	2.0		36,00 €
050.06.105.210		5.0	6.0	4.6	60.0	10.5	21.0	2.5		36,00 €
060.06.065.210		6.0	6.0	5.5	60.0	6.5	21.0	3.0		34,00 €
060.06.125.260		6.0	6.0	5.5	60.0	12.5	26.0	3.0		36,00 €
080.08.085.260		8.0	8.0	7.5	60.0	8.5	26.0	4.0		42,00 €
100.10.105.310		10.0	10.0	9.5	70.0	10.5	31.0	5.0		53,00 €

-5% > 5 STK. > 5 PCS. | -10% > 10 STK. > 10 PCS. | -20% > 20 STK. > 20 PCS.

FIRSTATTEC



VOLLRADIUSFRÄSER

3-SCHNEIDER, SCHAUMSTOFF BALL END MILL 3-FLUTE, FOAM

Stirnradius-Fräswerkzeug zur Zerspaltung von Schaumstoffen, z.B. für die 3-D.

Ball end mill for cutting foam, e.g. for 3-D machining.



ART.-NR. ARTICLE-CODE	GEWINDE THREAD	D1 (h9)	D2 (h6)	D3	L1	L2	L3	R	α	PREIS PRICE
		(mm)	(mm)							(mm)
HVDWN.										
030.03.065		3.0	3.0		40.0	6.5		1.5		33,00 €
030.06.125		3.0	6.0		50.0	12.5		1.5		44,00 €
040.06.165		4.0	6.0		50.0	16.5		2.0		46,00 €
050.06.205		5.0	6.0		60.0	20.5		2.5		50,00 €
060.06.185		6.0	6.0		50.0	18.5		3.0		51,00 €
060.06.265		6.0	6.0		60.0	26.5		3.0		54,00 €
080.08.325		8.0	8.0		70.0	32.5		4.0		66,00 €
100.10.405		10.0	10.0		80.0	40.5		5.0		86,00 €

-5%	-10%	-20%
> 5 STK.	> 10 STK.	> 20 STK.
> 5 PCS.	> 10 PCS.	> 20 PCS.

FIRSTATTEC



VOLLRADIUSFRÄSER

3-SCHNEIDER, FREISCHLIFF, SCHAUMSTOFF BALL END MILL 3-FLUTE, REDUCED NECK, FOAM

Stirnradius-Fräswerkzeug zur Zerspaltung von Schaumstoffen, z.B. für die 3-D Tiefenbearbeitung.

Ball end mill for cutting foam, e.g. for 3-D depth machining.

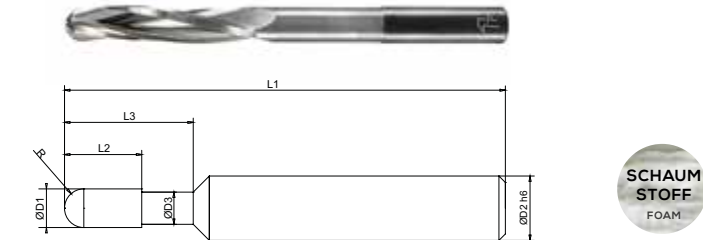

ART.-NR. ARTICLE-CODE	GEWINDE THREAD	D1 (h9)	D2 (h6)	D3	L1	L2	L3	R	α	PREIS PRICE
		(mm)	(mm)							(mm)
HVDWF.										
030.06.065.210		3.0	6.0	2.5	60.0	6.5	21.0	1.5		45,00 €
040.06.085.260		4.0	6.0	3.5	60.0	8.5	26.0	2.0		46,00 €
050.06.105.260		5.0	6.0	4.5	60.0	10.5	26.0	2.5		49,00 €
060.06.125.310		6.0	6.0	5.5	70.0	12.5	31.0	3.0		54,00 €
080.08.165.410		8.0	8.0	7.5	80.0	16.5	41.0	4.0		68,00 €
100.10.205.510		10.0	10.0	9.5	90.0	20.5	51.0	5.0		89,00 €

-5%	-10%	-20%
> 5 STK.	> 10 STK.	> 20 STK.
> 5 PCS.	> 10 PCS.	> 20 PCS.

FIRSTATTEC

SCHAFTFRÄSER
TORUSFRÄSER
VOLLRADIUSFRÄSER
ENTGRATWERKZEUGE
GRAVIERWERKZEUGE
GEWINDEWERKZEUGE
BOHRWERKZEUGE
SPEZIALWERKZEUGE



HSC-ENTGRATWERKZEUGE		ALUMINIUM	ALUMINIUM ELOXIERT	MESSING	KUPFER	KUNSTSTOFF	ACRYL	SCHAUMSTOFF	VORAUSWAHL		
									(MM)	(GRAD/ MM)	(KATALOG)
									D1	α°/R	SEITE
HEFSN.	Fasenfräser	●	●	●	●	●	●	●	3.0-10.0	60°-120°	85
HEFSB.	Fasenfräser Beschichtet	●	●	●	●	●	●	●	3.0-10.0	60°-120°	86
HEFZN.	Fasenfräser 1/8" Schaft	●	●	●	●	●	●	●	3.175	60°-120°	87
HEFWN.	Fasenfräser Schaumstoff	●	●	●	●	●	●	●	14.0-20.0	60°-90°	88
HEFPN.	Fasenfräser Poliert	●	●	●	●	●	●	●	3.0-10.0	60°-90°	89
HEFVN.	Vor- und Rückwärts-entgrater	●	●	●	●	●	●	●	5.0-12.0	60°-90°	90
HEFRN.	Rückwärtsentgrater	●	●	●	●	●	●	●	5.0-12.0	30°-45°	91
HEVSN.	Viertelkreisfräser	●	●	●	●	●	●	●	3.0-10.0	0.5-4.0	92
HEVPN.	Viertelkreisfräser Poliert	●	●	●	●	●	●	●	6.0-10.0	1.0-3.0	93

HSC-DEBURRING TOOLS		ALUMINIUM	ALUMINIUM ANODIZED	BRASS	COPPER	PLASTIC	ACRYLIC	FOAM	PRESELECTION		
									(MM)	(ANGLE/ MM)	(CATALOG)
									D1	α°/R	PAGE
HEFSN.	Chamfer	●	●	●	●	●	●	●	3.0-10.0	60°-120°	85
HEFSB.	Chamfer Coated	●	●	●	●	●	●	●	3.0-10.0	60°-120°	86
HEFZN.	Chamfer 1/8" Shank	●	●	●	●	●	●	●	3.175	60°-120°	87
HEFWN.	Chamfer Foam	●	●	●	●	●	●	●	14.0-20.0	60°-90°	88
HEFPN.	Chamfer Polished	●	●	●	●	●	●	●	3.0-10.0	60°-90°	89
HEFVN.	Chamfer Forward & Backward	●	●	●	●	●	●	●	5.0-12.0	60°-90°	90
HEFRN.	Chamfer Backward	●	●	●	●	●	●	●	5.0-12.0	30°-45°	91
HEVSN.	Corner Rounding Cutter	●	●	●	●	●	●	●	3.0-10.0	0.5-4.0	92
HEVPN.	Corner Rounding Cutter Polished	●	●	●	●	●	●	●	6.0-10.0	1.0-3.0	93



FASENFRÄSER

3-SCHNEIDER

CHAMFER MILLING TOOL 3-FLUTE

Universal Fasenfräser, verschiedene Winkel (α°) verfügbar.

Universal Chamfer Milling Tool, different angles (α°) available.

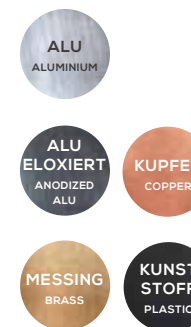
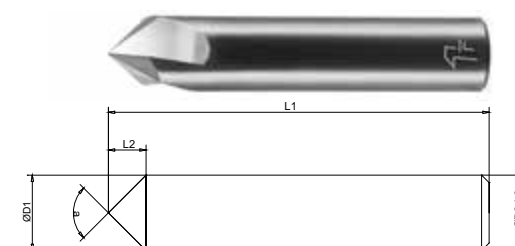

IHR VORSPRUNG
IST UNSER ZIEL.
COMMITTED TO PLACE YOU FIRST.

ART.-NR. ARTICLE-CODE	GEWINDE THREAD	D1 (h9)	D2 (h6)	D3	L1	L2	L3	R	α	PREIS PRICE
		(mm)	(mm)	(mm)	(mm)	(mm)	(mm)	(mm)		€/STK. €/PC.
HEFSN.										
030.03.060		3.0	3.0		40.0	2.5			60°	23,00 €
030.03.090		3.0	3.0		40.0	1.5			90°	23,00 €
030.03.120		3.0	3.0		40.0	0.8			120°	23,00 €
060.06.060		6.0	6.0		50.0	5.1			60°	27,00 €
060.06.090		6.0	6.0		50.0	3.0			90°	27,00 €
060.06.120		6.0	6.0		50.0	1.7			120°	27,00 €
080.08.060		8.0	8.0		50.0	6.9			60°	35,00 €
080.08.090		8.0	8.0		50.0	4.0			90°	35,00 €
080.08.120		8.0	8.0		50.0	2.3			120°	35,00 €
100.10.060		10.0	10.0		50.0	8.6			60°	47,00 €
100.10.090		10.0	10.0		50.0	5.0			90°	47,00 €
100.10.120		10.0	10.0		50.0	2.8			120°	47,00 €

-5%	-10%	-20%
> 5 STK.	> 10 STK.	> 20 STK.
> 5 PCS.	> 10 PCS.	> 20 PCS.



FIRSTATTEC



FASENFRÄSER

3-SCHNEIDER, BESCHICHTET CHAMFER MILLING TOOL 3-FLUTE, COATED

Universal Fasenfräser, verschiedene Winkel (α°) verfügbar. Modernste Beschichtungstechnologie für längere Standzeiten.

Universal Chamfer Milling Tool, different angles (α°) available. Cutting edge coating technology for longer tool life.

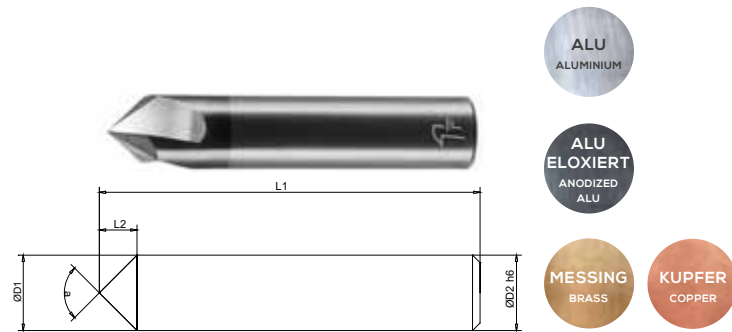

ART.-NR. ARTICLE-CODE	GEWINDE THREAD	D1 (h9)	D2 (h6)	D3	L1	L2	L3	R	α	PREIS PRICE
		(mm)	(mm)							(mm)
HEFSB.										
B01.030.03.060		3.0	3.0		40.0	2.5			60°	29,00 €
B01.030.03.090		3.0	3.0		40.0	1.5			90°	29,00 €
B01.030.03.120		3.0	3.0		40.0	0.8			120°	29,00 €
B01.060.06.060		6.0	6.0		50.0	5.1			60°	36,00 €
B01.060.06.090		6.0	6.0		50.0	3.0			90°	36,00 €
B01.060.06.120		6.0	6.0		50.0	1.7			120°	36,00 €
B01.080.08.060		8.0	8.0		50.0	6.9			60°	47,00 €
B01.080.08.090		8.0	8.0		50.0	4.0			90°	47,00 €
B01.080.08.120		8.0	8.0		50.0	2.3			120°	47,00 €
B01.100.10.060		10.0	10.0		50.0	8.6			60°	63,00 €
B01.100.10.090		10.0	10.0		50.0	5.0			90°	63,00 €
B01.100.10.120		10.0	10.0		50.0	2.8			120°	63,00 €

-5%	-10%	-20%
> 5 STK.	> 10 STK.	> 20 STK.
> 5 PCS.	> 10 PCS.	> 20 PCS.

FIRSTATTEC



FASENFRÄSER

3-SCHNEIDER, 1/8" SCHAFT CHAMFER MILLING TOOL 3-FLUTE, 1/8" SHANK

Universal Fasenfräser, verschiedene Winkel (α°) verfügbar.

Universal Chamfer Milling Tool, different angles (α°) available.

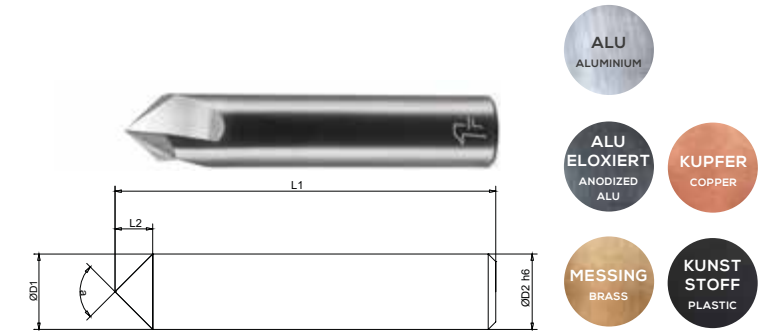

ART.-NR. ARTICLE-CODE	GEWINDE THREAD	D1 (h9)	D2 (h6)	D3	L1	L2	L3	R	α	PREIS PRICE
		(mm)	(mm)							(mm)
HEFZN.										
180.18.060		3.175	3.175		40.0	2.7			60°	22,00 €
180.18.090		3.175	3.175		40.0	1.5			90°	22,00 €
180.18.120		3.175	3.175		40.0	0.9			120°	22,00 €

-5%	-10%	-20%
> 5 STK.	> 10 STK.	> 20 STK.
> 5 PCS.	> 10 PCS.	> 20 PCS.

FIRSTATTEC

SCHAFTFRÄSER
TORUSFRÄSER
VOLLRADIUSFRÄSER
ENTGRATWERKZEUGE
GRAVIERWERKZEUGE
GEWINDEWERKZEUGE
BOHRWERKZEUGE
SPEZIALWERKZEUGE



FASENFRÄSER

3-SCHNEIDER, SCHAUMSTOFF CHAMFER MILLING TOOL 3-FLUTE, FOAM

Fasenfräser für Schaumstoffe, verschiedene Winkel (α°) verfügbar.

Chamfer Milling Tool for foam, different angles (α°) available.

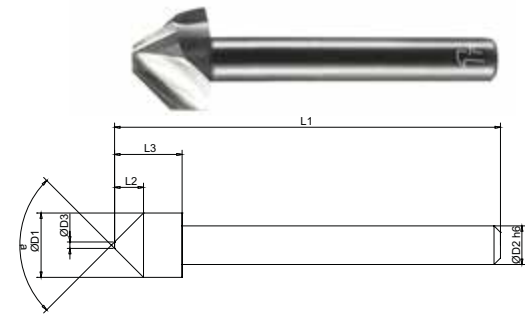

SCHAUMSTOFF
FOAM

ACRYL
ACRYLIC

ART.-NR. ARTICLE-CODE	GEWINDE THREAD	D1 (h9)	D2 (h6)	D3	L1	L2	L3	R	α	PREIS PRICE
		(mm)	(mm)	(mm)	(mm)	(mm)	(mm)	(mm)		€/STK. €/PC.
HEFWN.										
140.08.040.060		14.0	8.0	4.0	60.0	8.6	13.0		60°	109,00 €
140.08.040.090		14.0	8.0	4.0	60.0	5.0	13.0		90°	105,00 €
200.08.040.060		20.0	8.0	4.0	60.0	13.8	18.0		60°	189,00 €
200.08.040.090		20.0	8.0	4.0	60.0	8.0	18.0		90°	185,00 €

-5%	-10%	-20%
> 5 STK.	> 10 STK.	> 20 STK.
> 5 PCS.	> 10 PCS.	> 20 PCS.

FIRSTATTEC



FASENFRÄSER

4-SCHNEIDER, POLIERT CHAMFER MILLING TOOL 4-FLUTE, POLISHED

Fasenfräser für Kunststoffe und Acryl, verschiedene Winkel (α°) verfügbar.

Chamfer Milling Tool for plastics and acrylic, different angles (α°) available.

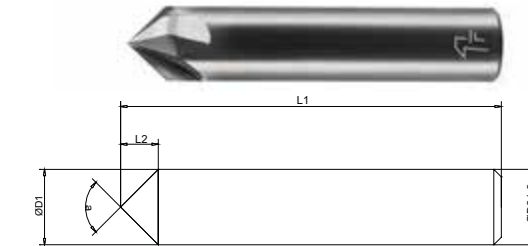

KUNSTSTOFF
PLASTIC

ACRYL
ACRYLIC

ART.-NR. ARTICLE-CODE	GEWINDE THREAD	D1 (h9)	D2 (h6)	D3	L1	L2	L3	R	α	PREIS PRICE
		(mm)	(mm)	(mm)	(mm)	(mm)	(mm)	(mm)		€/STK. €/PC.
HEFPN.										
030.03.060		3.0	3.0		40.0	2.5			60°	30,00 €
030.03.090		3.0	3.0		40.0	1.5			90°	29,00 €
060.06.060		6.0	6.0		50.0	5.1			60°	35,00 €
060.06.090		6.0	6.0		50.0	3.0			90°	34,00 €
080.08.060		8.0	8.0		50.0	6.9			60°	48,00 €
080.08.090		8.0	8.0		50.0	4.0			90°	46,00 €
100.10.060		10.0	10.0		50.0	8.6			60°	70,00 €
100.10.090		10.0	10.0		50.0	5.0			90°	68,00 €

-5%	-10%	-20%
> 5 STK.	> 10 STK.	> 20 STK.
> 5 PCS.	> 10 PCS.	> 20 PCS.

FIRSTATTEC

SCHAFTFRÄSER
TORUSFRÄSER
VOLLRADIUSFRÄSER
ENTGRATWERKZEUGE
GRAVIERWERKZEUGE
GEWINDEWERKZEUGE
BOHRWERKZEUGE
SPEZIALWERKZEUGE



VOR- UND RÜCKWÄRTSENTGRATER

3-SCHNEIDER

CHAMFER MILLING TOOL FORWARD & BACKWARD 3-FLUTE

Fasenfräser für Ober- und Unterkante ohne Umspannen, verschiedene Winkel (α°) verfügbar.

Chamfer Milling Tool for top and bottom edge without re-clamping, different angles (α°) available.

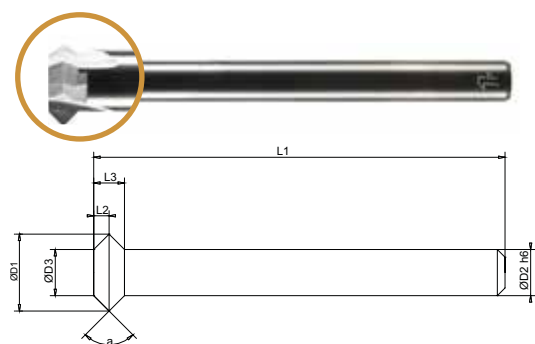

ART.-NR. ARTICLE-CODE	GEWINDE THREAD	D1 (h9)	D2 (h6)	D3	L1	L2	L3	R	α	PREIS PRICE
		(mm)	(mm)	(mm)	(mm)	(mm)	(mm)	(mm)		€/STK. €/PC.
HEFVN.										
050.03.030.060		5.0	3.0	3.0	60.0	0.55	1.1		60°	49,00 €
050.03.030.090		5.0	3.0	3.0	60.0	1.0	2.0		90°	49,00 €
090.06.060.060		9.0	6.0	6.0	70.0	0.85	1.7		60°	63,00 €
090.06.060.090		9.0	6.0	6.0	70.0	1.5	3.0		90°	63,00 €
120.08.080.060		12.0	8.0	8.0	80.0	1.15	2.3		60°	87,00 €
120.08.080.090		12.0	8.0	8.0	80.0	2.0	4.0		90°	87,00 €

-5%	-10%	-20%
> 5 STK.	> 10 STK.	> 20 STK.
> 5 PCS.	> 10 PCS.	> 20 PCS.

FIRSTATTEC



RÜCKWÄRTSENTGRATER

3-SCHNEIDER

CHAMFER MILLING TOOL BACKWARD 3-FLUTE

Fasenfräser für Unterkanten ohne Umspannen, verschiedene Winkel (α°) verfügbar.

Chamfer Milling Tool for bottom edge without re-clamping different angles (α°) available.

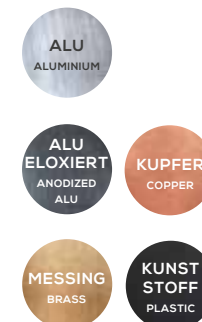
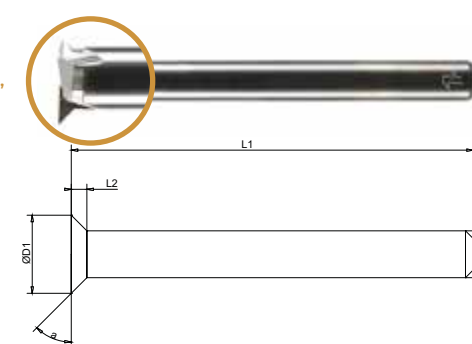

ART.-NR. ARTICLE-CODE	GEWINDE THREAD	D1 (h9)	D2 (h6)	D3	L1	L2	L3	R	α	PREIS PRICE
		(mm)	(mm)	(mm)	(mm)	(mm)	(mm)	(mm)		€/STK. €/PC.
HEFRN.										
050.03.030		5.0	3.0		60.0	0.55			30°	46,00 €
050.03.045		5.0	3.0		60.0	1.0			45°	46,00 €
090.06.030		9.0	6.0		70.0	0.85			30°	60,00 €
090.06.045		9.0	6.0		70.0	1.5			45°	60,00 €
120.08.030		12.0	8.0		80.0	1.15			30°	84,00 €
120.08.045		12.0	8.0		80.0	2.0			45°	84,00 €

-5%	-10%	-20%
> 5 STK.	> 10 STK.	> 20 STK.
> 5 PCS.	> 10 PCS.	> 20 PCS.

FIRSTATTEC



VIERTELKREISFRÄSER

3-SCHNEIDER

CORNER ROUNDING MILLING TOOL 3-FLUTE

Universal Viertelkreisfräser, verschiedene Radien (R) verfügbar.

Universal Corner Rounding Tool, different radii (R) available.

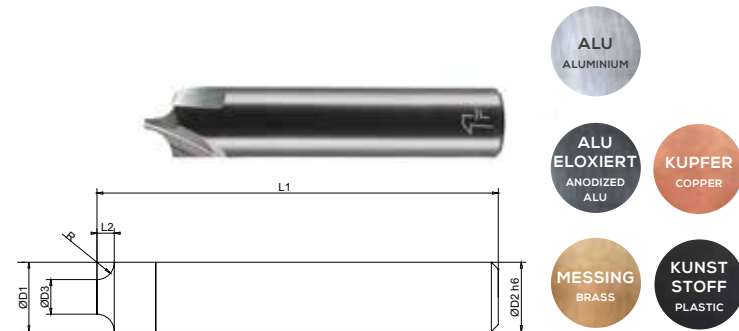

ART.-NR. ARTICLE-CODE	GEWINDE THREAD	D1 (h9)	D2 (h6)	D3	L1	L2	L3	R	α	PREIS PRICE
		(mm)	(mm)							(mm)
HEVSN.										
030.03.050		3.0	3.0	2.0	40.0	0.5		0.5		28,00 €
030.03.100		3.0	3.0	1.0	40.0	1.0		1.0		28,00 €
060.06.050		6.0	6.0	5.0	50.0	0.5		0.5		34,00 €
060.06.100		6.0	6.0	4.0	50.0	1.0		1.0		34,00 €
060.06.150		6.0	6.0	3.0	50.0	1.5		1.5		34,00 €
060.06.200		6.0	6.0	2.0	50.0	2.0		2.0		34,00 €
080.08.250		8.0	8.0	3.0	50.0	2.5		2.5		49,00 €
080.08.300		8.0	8.0	2.0	50.0	3.0		3.0		49,00 €
100.10.350		10.0	10.0	3.0	50.0	3.5		3.5		63,00 €
100.10.400		10.0	10.0	2.0	50.0	4.0		4.0		63,00 €

-5%	-10%	-20%
> 5 STK.	> 10 STK.	> 20 STK.
> 5 PCS.	> 10 PCS.	> 20 PCS.

FIRSTATTEC



VIERTELKREISFRÄSER

3-SCHNEIDER, POLIERT

CORNER ROUNDING MILLING TOOL 3-FLUTE, POLISHED

Viertelkreisfräser für Kunststoffe und Acryl, verschiedene Radien (R) verfügbar.

Corner Rounding Tool for plastics and acrylic, different radii (R) available.

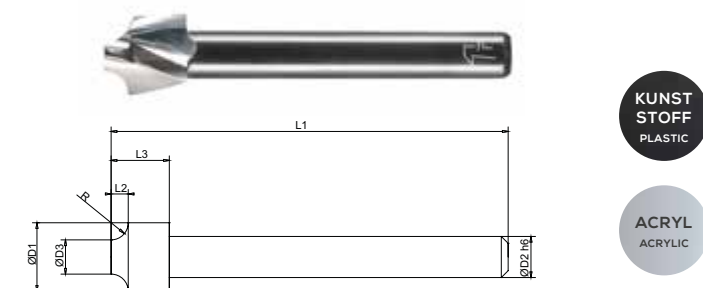

ART.-NR. ARTICLE-CODE	GEWINDE THREAD	D1 (h9)	D2 (h6)	D3	L1	L2	L3	R	α	PREIS PRICE
		(mm)	(mm)							(mm)
HEVSN.										
060.06.100		6.0	6.0	4.0	50.0	1.0	10.0	1.0		40,00 €
070.06.150		7.0	6.0	4.0	50.0	1.5	10.0	1.5		52,00 €
080.06.200		8.0	6.0	4.0	50.0	2.0	10.0	2.0		60,00 €
090.06.250		9.0	6.0	4.0	50.0	2.5	10.0	2.5		72,00 €
100.06.300		10.0	6.0	4.0	50.0	3.0	10.0	3.0		80,00 €

-5%	-10%	-20%
> 5 STK.	> 10 STK.	> 20 STK.
> 5 PCS.	> 10 PCS.	> 20 PCS.

FIRSTATTEC

SCHAFTFRÄSER
TORUSFRÄSER
VOLLRADIUSFRÄSER
ENTGRATWERKZEUGE
GRAVIERWERKZEUGE
GEWINDEWERKZEUGE
BOHRWERKZEUGE
SPEZIALWERKZEUGE



FIRSTATTEC HSC-WERKZEUGE

FIRSTATTEC HSC-TOOLS

HSC-GRAVIERWERKZEUGE		ALUMINIUM	ALUMINIUM ELOXIERT	MESSING	KUPFER	KUNSTSTOFF	ACRYL	SCHAUMSTOFF	VORAUSWAHL		
									(MM)	(GRAD)	(KATALOG)
									D1/R	α	SEITE
HCSSN.	Gravierstichel	●	●	●	●	●			0.1-0.2	20°-90°	97
HCSZN.	Gravierstichel 1/8" Schaft	●	●	●	●	●	●		0.1-0.2	20°-90°	99
HCSRN.	Radiusstichel	●	●	●	●	●	●		0.1-0.5	30°-60°	100
HCFSN.	Gravierfräser	●	●	●	●	●	●		1.0	20°-90°	101
HCFBN.	Gravierfräser Spanbrecher	●	●	●	●				1.0	20°-40°	103

HSC-ENGRAVING TOOLS		ALUMINIUM	ALUMINIUM ANODIZED	BRASS	COPPER	PLASTIC	ACRYLIC	FOAM	PRESELECTION		
									(MM)	(ANGLE)	(CATALOG)
									D1/R	α	PAGE
HCSSN.	Graver	●	●	●	●	●			0.1-0.2	20°-90°	97
HCSZN.	Graver 1/8" Shank	●	●	●	●	●	●		0.1-0.2	20°-90°	99
HCSRN.	Graver Radius	●	●	●	●	●	●		0.1-0.5	30°-60°	100
HCFSN.	Engraving Cutter	●	●	●	●	●	●		1.0	20°-90°	101
HCFBN.	Engraving Cutter Chipbreaker	●	●	●	●				1.0	20°-40°	103



SCHAFTFRÄSER
TORUSFRÄSER
VOLLRADIUSFRÄSER
ENTGRATWERKZEUGE
GRAVIERWERKZEUGE
GEWINDEWERKZEUGE
BOHRWERKZEUGE
SPEZIALWERKZEUGE

GRAVIERSTICHEL

1-SCHNEIDER GRAVER 1-FLUTE

Universal Gravierstichel zum Gravieren, Fasen und Entgraten, verschiedene Winkel (α°) verfügbar.

Universal engraving tool for engraving, chamfering and deburring, different angles (α°) available.

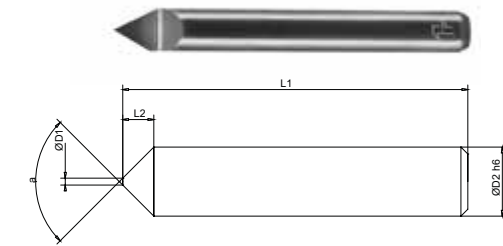

ART.-NR. ARTICLE-CODE	GEWINDE THREAD	D1 (mm)	D2 (h6) (mm)	D3 (mm)	L1 (mm)	L2 (mm)	L3 (mm)	R (mm)	α	PREIS PRICE
										€/STK. €/PC.
HCSSN.										
010.03.020		0.1	3.0		40.0	8.2			20°	14,00 €
010.03.030		0.1	3.0		40.0	5.4			30°	14,00 €
010.03.040		0.1	3.0		40.0	3.9			40°	14,00 €
010.03.050		0.1	3.0		40.0	3.1			50°	14,00 €
010.03.060		0.1	3.0		40.0	2.5			60°	14,00 €
010.03.090		0.1	3.0		40.0	1.4			90°	14,00 €
010.04.020		0.1	4.0		40.0	11.0			20°	17,00 €
010.04.030		0.1	4.0		40.0	7.2			30°	17,00 €
010.04.040		0.1	4.0		40.0	5.3			40°	17,00 €
010.04.050		0.1	4.0		40.0	4.1			50°	17,00 €
010.04.060		0.1	4.0		40.0	3.3			60°	17,00 €
010.04.090		0.1	4.0		40.0	1.9			90°	17,00 €
010.06.060		0.1	6.0		50.0	5.1			60°	22,00 €
010.06.090		0.1	6.0		50.0	2.9			90°	22,00 €

→ Fortsetzung auf Seite 98
Continued on page 98

-5%	-10%	-20%
> 5 STK.	> 10 STK.	> 20 STK.
> 5 PCS.	> 10 PCS.	> 20 PCS.



FIRSTATTEC

PERFEKTION
ENTSTEHT AUS ERFAHRUNG
UND LEIDENSCHAFT.
PERFECTION IS A MATTER OF
HEART AND EXPERIENCE.



ART.-NR. ARTICLE-CODE	GEWINDE THREAD	D1	D2 (h6)	D3	L1	L2	L3	R	α	PREIS
		(mm)	(mm)	(mm)	(mm)	(mm)	(mm)	(mm)		€/STK. €/PC.
HCSSN.										
020.03.020		0.2	3.0		40.0	7.9			20°	14,00 €
020.03.030		0.2	3.0		40.0	5.2			30°	14,00 €
020.03.040		0.2	3.0		40.0	3.8			40°	14,00 €
020.03.050		0.2	3.0		40.0	3.0			50°	14,00 €
020.03.060		0.2	3.0		40.0	2.4			60°	14,00 €
020.03.090		0.2	3.0		40.0	1.4			90°	14,00 €
020.04.020		0.2	4.0		40.0	10.7			20°	17,00 €
020.04.030		0.2	4.0		40.0	7.0			30°	17,00 €
020.04.040		0.2	4.0		40.0	5.2			40°	17,00 €
020.04.050		0.2	4.0		40.0	4.0			50°	17,00 €
020.04.060		0.2	4.0		40.0	3.2			60°	17,00 €
020.04.090		0.2	4.0		40.0	1.9			90°	17,00 €
020.06.060		0.2	6.0		50.0	5.0			60°	22,00 €
020.06.090		0.2	6.0		50.0	2.9			90°	22,00 €

GRAVIERSTICHEL

1-SCHNEIDER, 1/8" SCHAFT GRAVER 1-FLUTE, 1/8" SHANK

Universal Gravierstichel zum Gravieren,
Fasen und Entgraten, verschiedene
Winkel (α°) verfügbar.

Universal engraving tool for engraving,
chamfering and deburring, different
angles (α°) available.

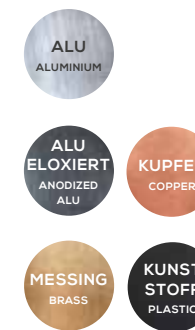
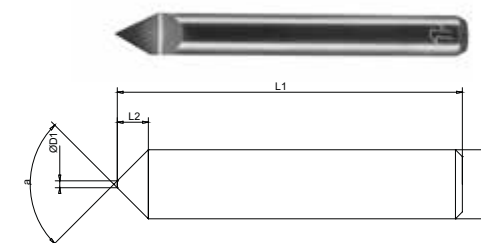

ART.-NR. ARTICLE-CODE	GEWINDE THREAD	D1	D2 (h6)	D3	L1	L2	L3	R	α	PREIS PRICE
		(mm)	(mm)	(mm)	(mm)	(mm)	(mm)	(mm)		€/STK. €/PC.
HCSZN.										
010.18.020		0.1	3.175		40.0	8.7			20°	13,00 €
010.18.030		0.1	3.175		40.0	5.7			30°	13,00 €
010.18.040		0.1	3.175		40.0	4.2			40°	13,00 €
010.18.050		0.1	3.175		40.0	3.2			50°	13,00 €
010.18.060		0.1	3.175		40.0	2.6			60°	13,00 €
010.18.090		0.1	3.175		40.0	1.5			90°	13,00 €
020.18.020		0.2	3.175		40.0	8.4			20°	13,00 €
020.18.030		0.2	3.175		40.0	5.5			30°	13,00 €
020.18.040		0.2	3.175		40.0	4.0			40°	13,00 €
020.18.050		0.2	3.175		40.0	3.1			50°	13,00 €
020.18.060		0.2	3.175		40.0	2.5			60°	13,00 €
020.18.090		0.2	3.175		40.0	1.4			90°	13,00 €

PRÄZISION IN PERFEKTION



-5% > 5 STK. | -10% > 10 STK. | -20% > 20 STK.
> 5 PCS. | > 10 PCS. | > 20 PCS.

FIRSTATTEC



GRAVIERSTICHEL

1-SCHNEIDER, MIT RADIUS GRAVER 1-FLUTE, WITH RADIUS

Gravierstichel mit Stirnradius für
verrundete Fräsbahnen, verschiedene
Winkel (α°) und Radien (R) verfügbar.

Engraving tool with radius for producing
rounded milling tracks, different angles (α°)
and radii (R) available.

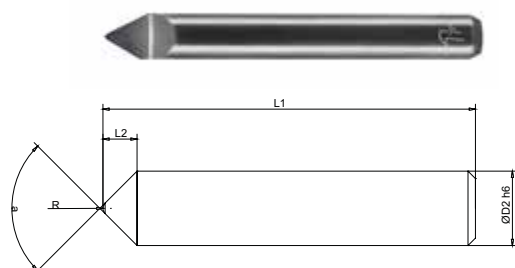

ART.-NR. ARTICLE-CODE	GEWINDE THREAD	D1 (mm)	D2 (h6) (mm)	D3 (mm)	L1 (mm)	L2 (mm)	L3 (mm)	R (mm)	α	PREIS PRICE
										€/STK. €/PC.
HCSRN.										
010.03.030			3.0		40.0	5.3		0.1	30°	32,00 €
010.03.040			3.0		40.0	3.9		0.1	40°	32,00 €
010.03.060			3.0		40.0	2.4		0.1	60°	32,00 €
010.04.030			4.0		40.0	7.1		0.1	30°	35,00 €
010.04.040			4.0		40.0	5.3		0.1	40°	35,00 €
010.04.060			4.0		40.0	3.3		0.1	60°	35,00 €
020.03.030			3.0		40.0	5.0		0.2	30°	26,00 €
020.03.040			3.0		40.0	3.7		0.2	40°	26,00 €
020.03.060			3.0		40.0	2.3		0.2	60°	26,00 €
020.04.030			4.0		40.0	6.8		0.2	30°	29,00 €
020.04.040			4.0		40.0	5.1		0.2	40°	29,00 €
020.04.060			4.0		40.0	3.2		0.2	60°	29,00 €
050.06.030			6.0		50.0	9.7		0.5	30°	34,00 €
050.06.040			6.0		50.0	7.2		0.5	40°	34,00 €
050.06.060			6.0		50.0	4.6		0.5	60°	34,00 €

-5% > 5 STK. | -10% > 10 STK. | -20% > 20 STK.
> 5 PCS. | > 10 PCS. | > 20 PCS.

FIRSTATTEC



GRAVIERFRÄSER

2-SCHNEIDER ENGRAVING MILLING TOOL 2-FLUTE

Gravierfräser zum Erzeugen von
breiten Frässpuren, verschiedene
Winkel (α°) verfügbar.

Engraving tool for producing wide milling
tracks, different angles (α°) available.

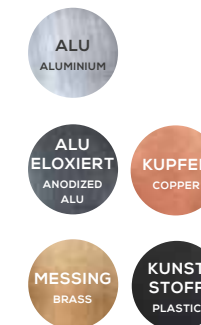
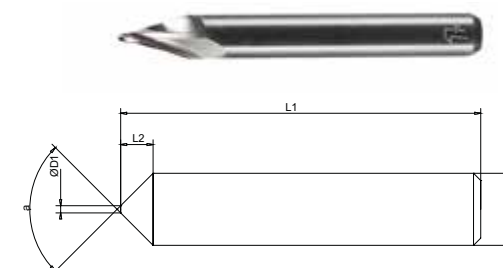

ART.-NR. ARTICLE-CODE	GEWINDE THREAD	D1 (mm)	D2 (h6) (mm)	D3 (mm)	L1 (mm)	L2 (mm)	L3 (mm)	R (mm)	α	PREIS PRICE
										€/STK. €/PC.
HCFSN.										
100.06.020		1.0	6.0		50.0	14.1			20°	42,00 €
100.06.030		1.0	6.0		50.0	9.3			30°	40,00 €
100.06.040		1.0	6.0		50.0	6.8			40°	38,00 €
100.06.060		1.0	6.0		50.0	4.3			60°	36,00 €
100.06.090		1.0	6.0		50.0	2.5			90°	34,00 €

-5% > 5 STK. | -10% > 10 STK. | -20% > 20 STK.
> 5 PCS. | > 10 PCS. | > 20 PCS.

FIRSTATTEC



PRÄZISION AUS EINER HAND

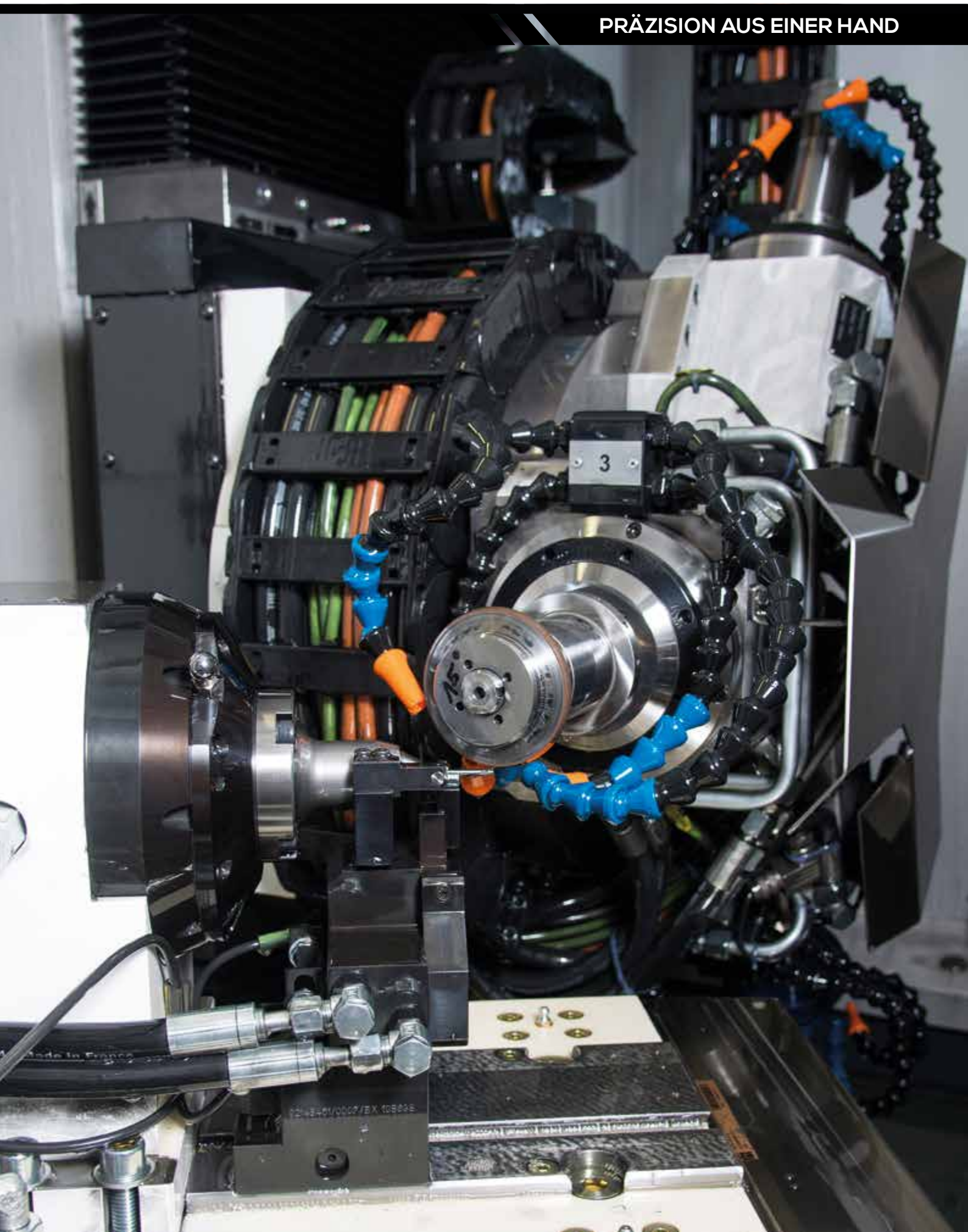

GRAVIERFRÄSER

2-SCHNEIDER, SPANBRECHER

ENGRAVING MILLING TOOL 2-FLUTE, CHIP BREAKER

Gravierfräser zum Schrumpfen von breiten Frässpuren mit kurzen Spänen, verschiedene Winkel (α°) verfügbar.

Engraving tool for roughing wide milling tracks with short chips, different angles (α°) available.

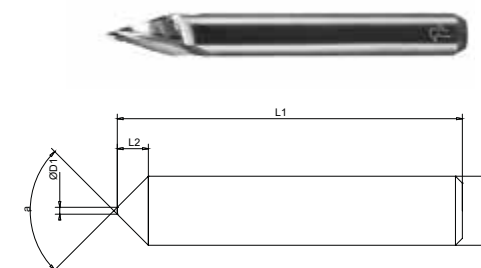

ART.-NR. ARTICLE-CODE	GEWINDE THREAD	D1	D2 (h6)	D3	L1	L2	L3	R	α	PREIS PRICE
		(mm)	(mm)	(mm)	(mm)	(mm)	(mm)	(mm)		€/STK. €/PC.
HCFBN.										
100.06.020		1.0	6.0		50.0	14.1			20°	49,00 €
100.06.030		1.0	6.0		50.0	9.3			30°	47,00 €
100.06.040		1.0	6.0		50.0	6.8			40°	45,00 €

-5%	-10%	-20%
> 5 STK.	> 10 STK.	> 20 STK.
> 5 PCS.	> 10 PCS.	> 20 PCS.

FIRSTATTEC



HSC-GEWINDEWERKZEUGE		ALUMINIUM	ALUMINIUM ELOXIERT	MESSING	KUPFER	KUNSTSTOFF	ACRYL	SCHAUMSTOFF	VORAUSWAHL		
									GEWINDE	(MM)	(KATALOG)
										D2	SEITE
HGWSN.	Gewindewirbler	●	●	●	●	●			M1-M10	3.0-8.0	107
HGWSB.	Gewindewirbler Beschichtet	●	●	●	●				M1-M10	3.0-8.0	109
HGWAN.	Gewindewirbler Multi	●	●	●	●	●	●		M1-M16	3.0-8.0	111
HGWPN.	Gewindewirbler Poliert					●	●		M1-M10	3.0-8.0	112
HGWBN.	Bohrgewindewirbler	●	●	●	●	●			M2-M6	6.0	113

HSC-THREAD TOOLS		ALUMINIUM	ALUMINIUM ANODIZED	BRASS	COPPER	PLASTIC	ACRYLIC	FOAM	PRESELECTION		
									THREAD	(MM)	(CATALOG)
										D2	PAGE
HGWSN.	Thread Whirling	●	●	●	●	●			M1-M10	3.0-8.0	107
HGWSB.	Thread Whirling Coated	●	●	●	●				M1-M10	3.0-8.0	109
HGWAN.	Thread Whirling Multi	●	●	●	●	●	●		M1-M16	3.0-8.0	111
HGWPN.	Thread Whirling Polished					●	●		M1-M10	3.0-8.0	112
HGWBN.	Drill Thread Whirling	●	●	●	●	●			M2-M6	6.0	113



GEWINDEWIRBLER

2/4-SCHNEIDER

WHIRLING THREAD CUTTER 2/4-FLUTE

Gewindewirbler mit verschiedenen Nutztiefen. Größen optimiert und ausgelegt für die Serienbearbeitung. Ab M2.5 als 4-Schneider ausgelegt.

Whirling thread cutter with different useful depths. Sizes optimized and designed for series machining. From M2.5 designed as a 4-flute cutter.

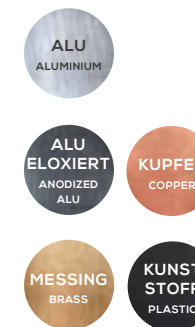
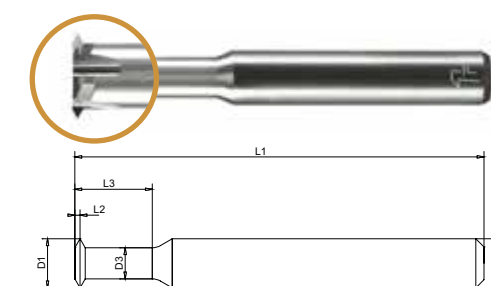

**FORTSCHRITT
HAT PRIORITÄT.
PROGRESS HAS PRIORITY.**

ART.-NR. ARTICLE-CODE	GEWINDE THREAD	D1 (mm)	D2 (h6) (mm)	D3 (mm)	L1 (mm)	L2 (mm)	L3 (mm)	R (mm)	α	PREIS PRICE
										€/STK. €/PC.
HGWSN.										
M010.03.035	M1	0.7	3.0	0.4	40.0	0.09	3.5			50,00 €
M010.03.065	M1	0.7	3.0	0.4	40.0	0.09	6.5			52,00 €
M020.03.045	M2	1.5	3.0	1.0	40.0	0.14	4.5			49,00 €
M020.03.085	M2	1.5	3.0	1.0	40.0	0.14	8.5			50,00 €
M025.03.055	M2.5	1.9	3.0	1.3	40.0	0.17	5.5			48,00 €
M025.03.105	M2.5	1.9	3.0	1.3	40.0	0.17	10.5			50,00 €
M030.03.065	M3	2.3	3.0	1.6	40.0	0.20	6.5			48,00 €
M030.06.125	M3	2.3	6.0	1.6	50.0	0.20	12.5			57,00 €
M040.06.085	M4	3.1	6.0	2.2	50.0	0.26	8.5			55,00 €
M040.06.165	M4	3.1	6.0	2.2	50.0	0.26	16.5			57,00 €
M050.06.105	M5	4.0	6.0	3.0	50.0	0.29	10.5			55,00 €
M050.06.205	M5	4.0	6.0	3.0	60.0	0.29	20.5			58,00 €

→ Fortsetzung auf Seite 108
Continued on page 108

-5%	-10%	-20%
> 5 STK.	> 10 STK.	> 20 STK.
> 5 PCS.	> 10 PCS.	> 20 PCS.



FIRSTATTEC



ART.-NR. ARTICLE-CODE	GEWINDE THREAD	D1	D2 (h6)	D3	L1	L2	L3	R	α	PREIS
		(mm)	(mm)	(mm)	(mm)	(mm)	(mm)	(mm)		€/STK. €/PC.
HGWSN.										
M060.06.125	M6	4.8	6.0	3.6	50.0	0.35	12.5			55,00 €
M060.06.245	M6	4.8	6.0	3.6	60.0	0.35	24.5			58,00 €
M080.08.165	M8	6.5	8.0	5.0	50.0	0.43	16.5			63,00 €
M080.08.325	M8	6.5	8.0	5.0	70.0	0.43	32.5			67,00 €
M100.08.205	M10	7.9	8.0	6.1	60.0	0.52	20.5			64,00 €
M100.08.405	M10	7.9	8.0	6.1	80.0	0.52	40.5			68,00 €

LIEFERTREUE DURCH EIGENE KAPAZITÄTEN



GEWINDEWIRBLER

2/4-SCHNEIDER, BESCHICHTET
WHIRLING THREAD CUTTER 2/4-FLUTE, COATED

Gewindewirbler mit verschiedenen Nutztiefen. Größen optimiert und ausgelegt für die Serienbearbeitung. Modernste Beschichtungstechnologie für längere Standzeiten. Ab M2.5 als 4-Schneider ausgelegt.

Whirling thread cutter with different useful depths. Sizes optimized and designed for series machining. Cutting edge coating technology for longer tool life. From M2.5 designed as a 4-flute cutter.

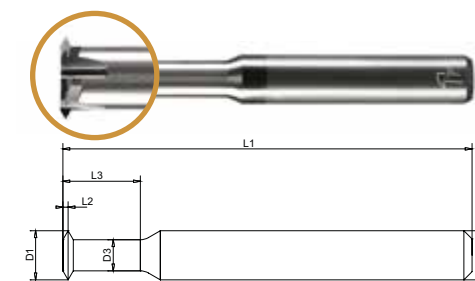

ART.-NR. ARTICLE-CODE	GEWINDE THREAD	D1	D2 (h6)	D3	L1	L2	L3	R	α	PREIS PRICE
		(mm)	(mm)	(mm)	(mm)	(mm)	(mm)	(mm)		€/STK. €/PC.
HGWSB.										
B01.M010.03.035	M1	0.7	3.0	0.4	40.0	0.09	3.5			56,00 €
B01.M010.03.065	M1	0.7	3.0	0.4	40.0	0.09	6.5			58,00 €
B01.M020.03.045	M2	1.5	3.0	1.0	40.0	0.14	4.5			55,00 €
B01.M020.03.085	M2	1.5	3.0	1.0	40.0	0.14	8.5			56,00 €
B01.M025.03.055	M2.5	1.9	3.0	1.3	40.0	0.17	5.5			54,00 €
B01.M025.03.105	M2.5	1.9	3.0	1.3	40.0	0.17	10.5			56,00 €
B01.M030.03.065	M3	2.3	3.0	1.6	40.0	0.20	6.5			54,00 €
B01.M030.06.125	M3	2.3	6.0	1.6	50.0	0.20	12.5			66,00 €
B01.M040.06.085	M4	3.1	6.0	2.2	50.0	0.26	8.5			64,00 €
B01.M040.06.165	M4	3.1	6.0	2.2	50.0	0.26	16.5			66,00 €
B01.M050.06.105	M5	4.0	6.0	3.0	50.0	0.29	10.5			64,00 €
B01.M050.06.205	M5	4.0	6.0	3.0	60.0	0.29	20.5			67,00 €

→ Fortsetzung auf Seite 110
Continued on page 110

-5%	-10%	-20%
> 5 STK.	> 10 STK.	> 20 STK.
> 5 PCS.	> 10 PCS.	> 20 PCS.

FIRSTATTEC



ART.-NR. ARTICLE-CODE	GEWINDE THREAD	D1	D2 (h6)	D3	L1	L2	L3	R	α	PREIS
		(mm)	(mm)	(mm)	(mm)	(mm)	(mm)	(mm)		€/STK. €/PC.
HGWSB.										
B01.M060.06.125	M6	4.8	6.0	3.6	50.0	0.35	12.5			64,00 €
B01.M060.06.245	M6	4.8	6.0	3.6	60.0	0.35	24.5			67,00 €
B01.M080.08.165	M8	6.5	8.0	5.0	50.0	0.43	16.5			75,00 €
B01.M080.08.325	M8	6.5	8.0	5.0	70.0	0.43	32.5			79,00 €
B01.M100.08.205	M10	7.9	8.0	6.1	60.0	0.52	20.5			76,00 €
B01.M100.08.405	M10	7.9	8.0	6.1	80.0	0.52	40.5			80,00 €

GEWINDEWIRBLER

2/4-SCHNEIDER, MULTI WHIRLING THREAD CUTTER 2/4-FLUTE, MULTI

Gewindewirbler mit verschiedenen Nutstiefen. Verschiedene Gewindegrößen je Werkzeug fräsbar. Ab M2.5 als 4-Schneider ausgelegt.

Whirling thread cutter with different useful depths. Various thread sizes per tool can be milled. From M2.5 designed as a 4-flute cutter.

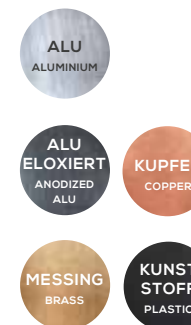
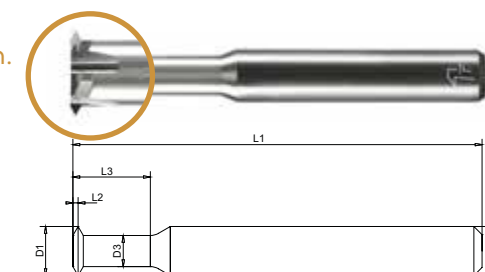

INNOVATION TRIFFT AUF TRADITION

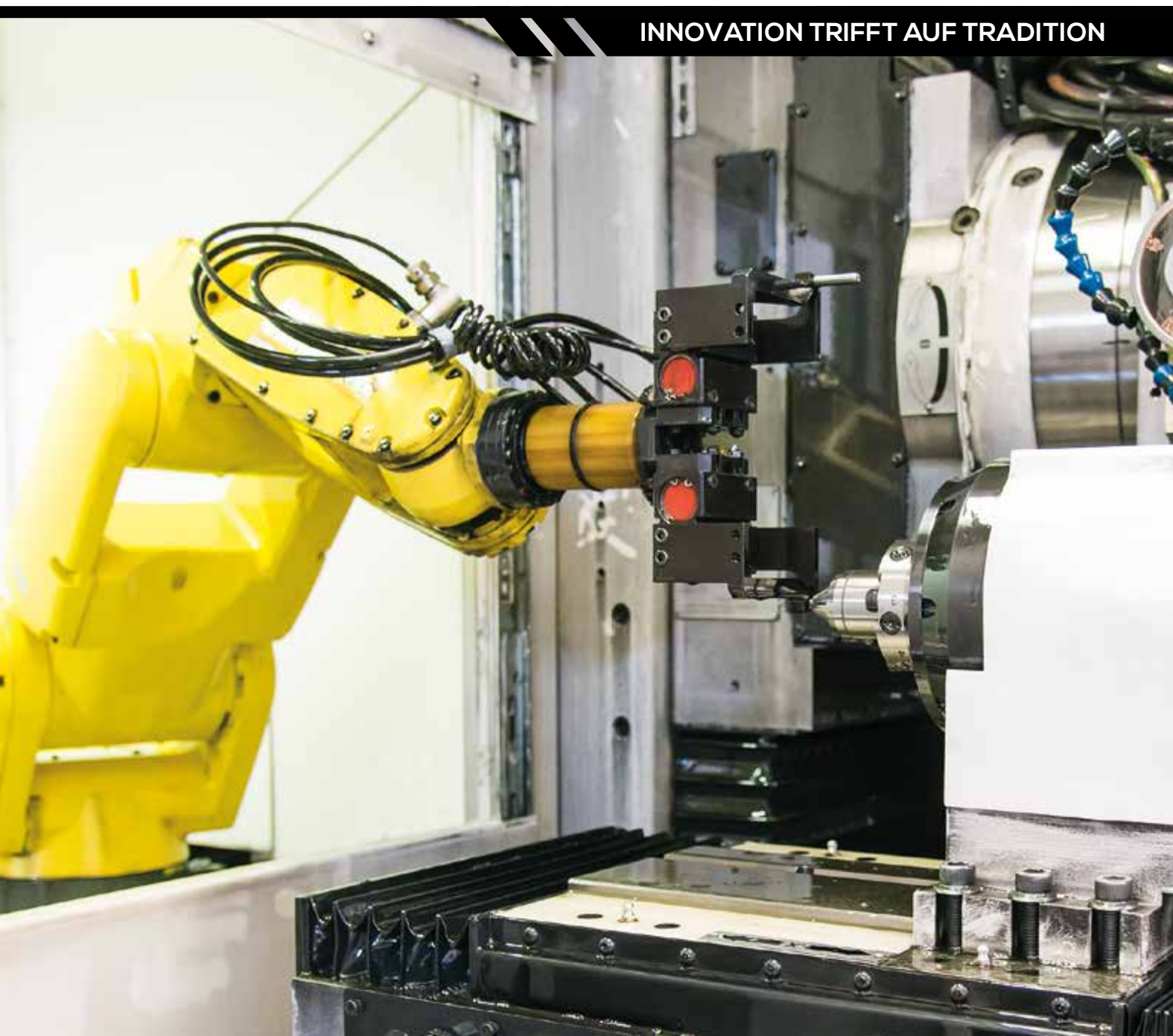

ART.-NR. ARTICLE-CODE	GEWINDE THREAD	D1	D2 (h6)	D3	L1	L2	L3	R	α	PREIS PRICE
		(mm)	(mm)	(mm)	(mm)	(mm)	(mm)	(mm)		€/STK. €/PC.
HGWAN.										
M010.M014.03.035	M1 - M1,4	0.7	3.0	0.35	40.0	0.10	3.5			51,00 €
M010.M014.03.065	M1 - M1,4	0.7	3.0	0.35	40.0	0.10	6.5			53,00 €
M016.M025.03.065	M1,6 - M2,5	1.1	3.0	0.55	40.0	0.16	6.5			50,00 €
M016.M025.03.105	M1,6 - M2,5	1.1	3.0	0.55	40.0	0.16	10.5			51,00 €
M025.M040.03.055	M2,5 - M4	1.9	3.0	1.00	40.0	0.26	5.5			49,00 €
M025.M040.03.085	M2,5 - M4	1.9	3.0	1.00	40.0	0.26	8.5			50,00 €
M025.M040.03.105	M2,5 - M4	1.9	3.0	1.00	40.0	0.26	10.5			51,00 €
M025.M040.03.125	M2,5 - M4	1.9	3.0	1.00	40.0	0.26	12.5			51,00 €
M050.M100.06.105	M5 - M10	4.0	6.0	2.20	50.0	0.52	10.5			57,00 €
M050.M100.06.125	M5 - M10	4.0	6.0	2.20	60.0	0.52	12.5			57,00 €
M050.M100.06.165	M5 - M10	4.0	6.0	2.20	50.0	0.52	16.5			58,00 €
M050.M100.06.205	M5 - M10	4.0	6.0	2.20	60.0	0.52	20.5			60,00 €
M100.M160.08.165	M10 - M16	7.9	8.0	5.50	50.0	0.69	16.5			67,00 €
M100.M160.08.305	M10 - M16	7.9	8.0	5.50	70.0	0.69	30.5			71,00 €

-5%	-10%	-20%
> 5 STK.	> 10 STK.	> 20 STK.
> 5 PCS.	> 10 PCS.	> 20 PCS.

FIRSTATTEC



GEWINDEWIRBLER

2-SCHNEIDER, POLIERT

WHIRLING THREAD CUTTER 2-FLUTE, POLISHED

Gewindewirbler für Kunststoffe und Acryl. Größen optimiert und ausgelegt für die Serienbearbeitung.

Whirling thread cutter for plastics and acrylic. Sizes optimized and designed for series machining.

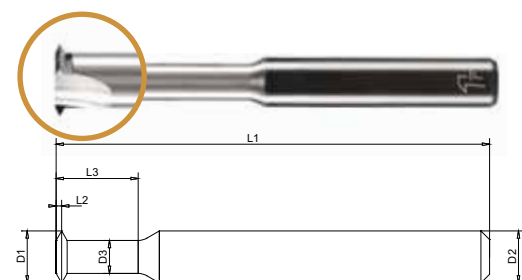

KUNSTSTOFF
PLASTIC

ACRYL
ACRYLIC

ART.-NR. ARTICLE-CODE	GEWINDE THREAD	D1 (mm)	D2 (h6) (mm)	D3 (mm)	L1 (mm)	L2 (mm)	L3 (mm)	R (mm)	α	PREIS PRICE
										€/STK. €/PC.
HGWPN.										
M010.03.065	M1	0.7	3.0	0.4	40.0	0.09	6.5			58,00 €
M020.03.085	M2	1.5	3.0	1.0	40.0	0.14	8.5			56,00 €
M025.03.105	M2.5	1.9	3.0	1.3	40.0	0.17	10.5			56,00 €
M030.06.125	M3	2.3	6.0	1.6	50.0	0.20	12.5			64,00 €
M040.06.165	M4	3.1	6.0	2.2	50.0	0.26	16.5			64,00 €
M050.06.165	M5	4.0	6.0	3.0	50.0	0.29	16.5			65,00 €
M060.06.205	M6	4.8	6.0	3.6	60.0	0.35	20.5			65,00 €
M080.08.255	M8	6.5	8.0	5.0	60.0	0.43	25.5			76,00 €
M100.08.305	M10	7.9	8.0	6.1	70.0	0.52	30.5			77,00 €

-5%	-10%	-20%
> 5 STK.	> 10 STK.	> 20 STK.
> 5 PCS.	> 10 PCS.	> 20 PCS.

FIRSTATTEC



BOHRGEWINDEWIRBLER

3-SCHNEIDER

DRILLING-WHIRLING THREAD CUTTER 3-FLUTE

Bohrgewindefräser für Kernloch und Gewinde in einem Arbeitsgang.

Milling tool for core hole and thread in one operation.

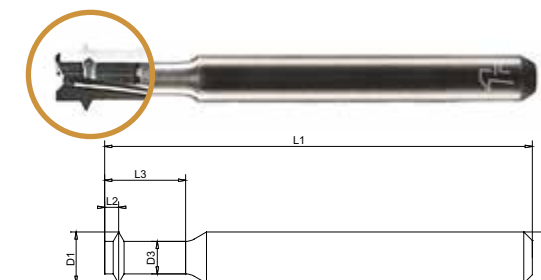

ALU
ALUMINIUM

ALU
ELOXIERT
ANODIZED
ALU

KUNSTSTOFF
PLASTIC

ART.-NR. ARTICLE-CODE	GEWINDE THREAD	D1 (mm)	D2 (h6) (mm)	D3 (mm)	L1 (mm)	L2 (mm)	L3 (mm)	R (mm)	α	PREIS PRICE
										€/STK. €/PC.
HGWBN.										
M020.03.085	M2	1.5	3.0	1.0	40.0	0.52	8.5			58,00 €
M025.03.085	M2.5	1.9	3.0	1.3	40.0	0.58	8.5			58,00 €
M030.03.085	M3	2.3	3.0	1.6	40.0	0.64	8.5			58,00 €
M040.06.105	M4	3.1	6.0	2.2	50.0	0.90	10.5			61,00 €
M050.06.105	M5	4.0	6.0	3.0	50.0	1.03	10.5			61,00 €
M060.06.125	M6	4.8	6.0	3.6	50.0	1.29	12.5			61,00 €

-5%	-10%	-20%
> 5 STK.	> 10 STK.	> 20 STK.
> 5 PCS.	> 10 PCS.	> 20 PCS.

FIRSTATTEC



FIRSTATTEC HSC-WERKZEUGE

FIRSTATTEC HSC-TOOLS



HSC-BOHRWERKZEUGE		ALUMINIUM	ALUMINIUM ELOXIERT	MESSING	KUPFER	KUNSTSTOFF	ACRYL	SCHAUMSTOFF	VORAUSWAHL		
									(MM)	(MM)	(KATALOG)
									D1	D2	SEITE
HBSSN.	Spiralbohrer	●	●	●	●	●	●		3.0-10.0	6.0-10.0	117
HBSSB.	Spiralbohrer Beschichtet	●	●	●	●	●	●		3.0-10.0	6.0-10.0	119

HSC-DRILLING TOOLS		ALUMINIUM	ALUMINIUM ANODIZED	BRASS	COPPER	PLASTIC	ACRYLIC	FOAM	PRESELECTION		
									(MM)	(MM)	(CATALOG)
									D1	D2	PAGE
HBSSN.	Drilling Tool	●	●	●	●	●	●		3.0-10.0	6.0-10.0	117
HBSSB.	Drilling Tool Coated	●	●	●	●	●	●		3.0-10.0	6.0-10.0	119

FIRSTATTEC HSC-WERKZEUGE

FIRSTATTEC HSC-TOOLS

HSC-SPEZIALWERKZEUGE		ALUMINIUM	ALUMINIUM ELOXIERT	MESSING	KUPFER	KUNSTSTOFF	ACRYL	SCHAUMSTOFF	VORAUSWAHL		
									(MM)	(MM)	(KATALOG)
									D1	D2	SEITE
HANSN.	Nutfräser	●	●	●	●	●	●		3.0-10.0	3.0-10.0	121
HANAN.	Nutfräser Abgestuft	●	●	●	●	●	●		6.0-20.0	3.0-10.0	123

HSC-SPECIAL TOOLS		ALUMINIUM	ALUMINIUM ANODIZED	BRASS	COPPER	PLASTIC	ACRYLIC	FOAM	PRESELECTION		
									(MM)	(MM)	(CATALOG)
									D1	D2	PAGE
HANSN.	Slotting Cutter	●	●	●	●	●	●		3.0-10.0	3.0-10.0	121
HANAN.	Slotting Cutter Stepped	●	●	●	●	●	●		6.0-20.0	3.0-10.0	123



• BE FAST. BE FIRST. BE FIRSTATTEC •

SPIRALBOHRER

2-SCHNEIDER DRILLING TOOL 2-FLUTE

Werkzeug zum Bohren von NE-Metallen.
Tool for drilling non-ferrous metals.

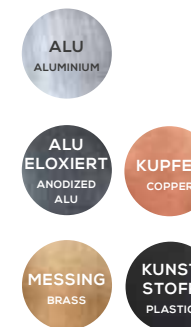
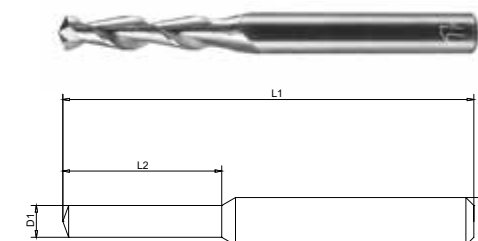

ART.-NR. ARTICLE-CODE	GEWINDE THREAD	D1 (h9)	D2 (h6)	D3	L1	L2	L3	R	α	PREIS PRICE
		(mm)	(mm)	(mm)	(mm)	(mm)	(mm)	(mm)		€/STK. €/PC.
HBSSN.										
030.06.210		3.0	6.0		60.0	21.0				28,00 €
032.06.210		3.2	6.0		60.0	21.0				28,00 €
033.06.210		3.3	6.0		60.0	21.0				28,00 €
035.06.210		3.5	6.0		60.0	21.0				28,00 €
038.06.210		3.8	6.0		60.0	21.0				28,00 €
040.06.210		4.0	6.0		60.0	21.0				28,00 €
042.06.210		4.2	6.0		60.0	21.0				28,00 €
045.06.210		4.5	6.0		60.0	21.0				28,00 €
048.06.210		4.8	6.0		60.0	21.0				28,00 €
050.06.210		5.0	6.0		60.0	21.0				28,00 €
052.06.210		5.2	6.0		60.0	21.0				28,00 €
055.06.210		5.5	6.0		60.0	21.0				28,00 €
058.06.210		5.8	6.0		60.0	21.0				28,00 €
060.06.210		6.0	6.0		60.0	21.0				28,00 €

→ Fortsetzung auf Seite 118
Continued on page 118

-5%	-10%	-20%
> 5 STK.	> 10 STK.	> 20 STK.
> 5 PCS.	> 10 PCS.	> 20 PCS.



FIRSTATTEC

FIRSTATTEC GMBH | CARL-BENZ-STR. 5 | 68723 SCHWETZINGEN
☎ 0 8000 150 250 | CONTACT@FIRSTATTEC.DE ☏
• WWW.FIRSTATTEC.DE •

INNOVATIONEN
ENTSTEHEN BEIM EXPERTEN.
BECAUSE INNOVATIONS ARE
CREATED BY EXPERTS.



ART.-NR. ARTICLE-CODE	GEWINDE THREAD	D1 (h9)	D2 (h6)	D3	L1	L2	L3	R	α	PREIS
		(mm)	(mm)	(mm)	(mm)	(mm)	(mm)	(mm)		€/STK. €/PC.
HBSSN.										
060.06.310		6.0	6.0		70.0	31.0				30,00 €
062.08.310		6.2	8.0		70.0	31.0				38,00 €
065.08.310		6.5	8.0		70.0	31.0				38,00 €
068.08.310		6.8	8.0		70.0	31.0				38,00 €
070.08.310		7.0	8.0		70.0	31.0				38,00 €
072.08.310		7.2	8.0		70.0	31.0				38,00 €
075.08.310		7.5	8.0		70.0	31.0				38,00 €
078.08.310		7.8	8.0		70.0	31.0				38,00 €
080.08.310		8.0	8.0		70.0	31.0				38,00 €
082.10.310		8.2	10.0		70.0	31.0				48,00 €
085.10.310		8.5	10.0		70.0	31.0				48,00 €
088.10.310		8.8	10.0		70.0	31.0				48,00 €
090.10.310		9.0	10.0		70.0	31.0				48,00 €
092.10.310		9.2	10.0		70.0	31.0				48,00 €
095.10.310		9.5	10.0		70.0	31.0				48,00 €
098.10.310		9.8	10.0		70.0	31.0				48,00 €
100.10.310		10.0	10.0		70.0	31.0				48,00 €

SPIRALBOHRER

2-SCHNEIDER, BESCHICHTET DRILLING TOOL 2-FLUTE, COATED

Werkzeug zum Bohren von NE-Metallen.
Modernste Beschichtungstechnologie für
längere Standzeiten.

Tool for drilling non-ferrous metals.
Cutting edge coating technology for
longer tool life.

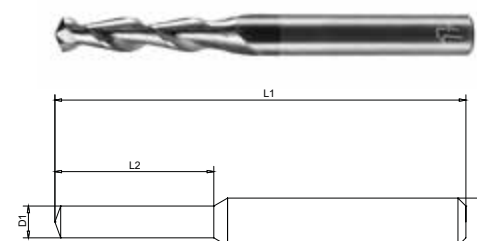

ART.-NR. ARTICLE-CODE	GEWINDE THREAD	D1 (h9)	D2 (h6)	D3	L1	L2	L3	R	α	PREIS PRICE
		(mm)	(mm)	(mm)	(mm)	(mm)	(mm)	(mm)		€/STK. €/PC.
HBSSB.										
B01.030.06.210		3.0	6.0		60.0	21.0				37,00 €
B01.032.06.210		3.2	6.0		60.0	21.0				37,00 €
B01.033.06.210		3.3	6.0		60.0	21.0				37,00 €
B01.035.06.210		3.5	6.0		60.0	21.0				37,00 €
B01.038.06.210		3.8	6.0		60.0	21.0				37,00 €
B01.040.06.210		4.0	6.0		60.0	21.0				37,00 €
B01.042.06.210		4.2	6.0		60.0	21.0				37,00 €
B01.045.06.210		4.5	6.0		60.0	21.0				37,00 €
B01.048.06.210		4.8	6.0		60.0	21.0				37,00 €
B01.050.06.210		5.0	6.0		60.0	21.0				37,00 €
B01.052.06.210		5.2	6.0		60.0	21.0				37,00 €
B01.055.06.210		5.5	6.0		60.0	21.0				37,00 €
B01.058.06.210		5.8	6.0		60.0	21.0				37,00 €
B01.060.06.210		6.0	6.0		60.0	21.0				37,00 €

→ Fortsetzung auf Seite 120
Continued on page 120

-5%	-10%	-20%
> 5 STK.	> 10 STK.	> 20 STK.
> 5 PCS.	> 10 PCS.	> 20 PCS.

FIRSTATTEC

SCHLEIFEN IST UNSER ZUHAUSE





ART.-NR. ARTICLE-CODE	GEWINDE THREAD	D1 (h9)	D2 (h6)	D3	L1	L2	L3	R	α	PREIS
		(mm)	(mm)							(mm)
HBSSB.										
B01.060.06.310		6.0	6.0		70.0	31.0				39,00 €
B01.062.08.310		6.2	8.0		70.0	31.0				50,00 €
B01.065.08.310		6.5	8.0		70.0	31.0				50,00 €
B01.068.08.310		6.8	8.0		70.0	31.0				50,00 €
B01.070.08.310		7.0	8.0		70.0	31.0				50,00 €
B01.072.08.310		7.2	8.0		70.0	31.0				50,00 €
B01.075.08.310		7.5	8.0		70.0	31.0				50,00 €
B01.078.08.310		7.8	8.0		70.0	31.0				50,00 €
B01.080.08.310		8.0	8.0		70.0	31.0				50,00 €
B01.082.10.310		8.2	10.0		70.0	31.0				64,00 €
B01.085.10.310		8.5	10.0		70.0	31.0				64,00 €
B01.088.10.310		8.8	10.0		70.0	31.0				64,00 €
B01.090.10.310		9.0	10.0		70.0	31.0				64,00 €
B01.092.10.310		9.2	10.0		70.0	31.0				64,00 €
B01.095.10.310		9.5	10.0		70.0	31.0				64,00 €
B01.098.10.310		9.8	10.0		70.0	31.0				64,00 €
B01.100.10.310		10.0	10.0		70.0	31.0				64,00 €

NUTFRÄSER

3-SCHNEIDER SLOTING TOOL 3-FLUTE

Fräs Werkzeug zum Herstellen von T-Nuten mit verschiedenen Nutbreiten verfügbar.

Milling tool for producing T-slots with different groove widths available.

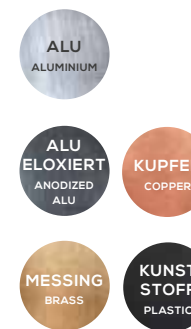
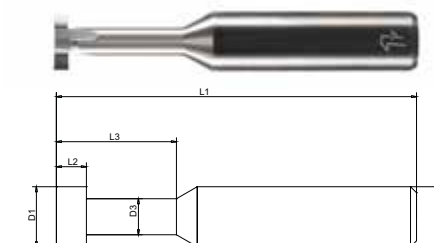

ART.-NR. ARTICLE-CODE	GEWINDE THREAD	D1 (h9)	D2 (h6)	D3	L1	L2	L3	R	α	PREIS PRICE
		(mm)	(mm)							(mm)
HANSN.										
030.03.005.045		3.0	3.0	2.0	40.0	0.5	4.5			40,00 €
030.03.010.065		3.0	3.0	1.8	40.0	1.0	6.5			42,00 €
060.06.010.085		6.0	6.0	2.9	50.0	1.0	8.5			58,00 €
060.06.015.125		6.0	6.0	2.8	50.0	1.5	12.5			60,00 €
080.08.015.125		8.0	8.0	4.8	50.0	1.5	12.5			64,00 €
080.08.020.165		8.0	8.0	3.8	50.0	2.0	16.5			66,00 €
100.10.020.165		10.0	10.0	4.9	60.0	2.0	16.5			70,00 €
100.10.025.205		10.0	10.0	4.8	60.0	2.5	20.5			72,00 €

EFFIZIENZ DURCH AUTOMATION

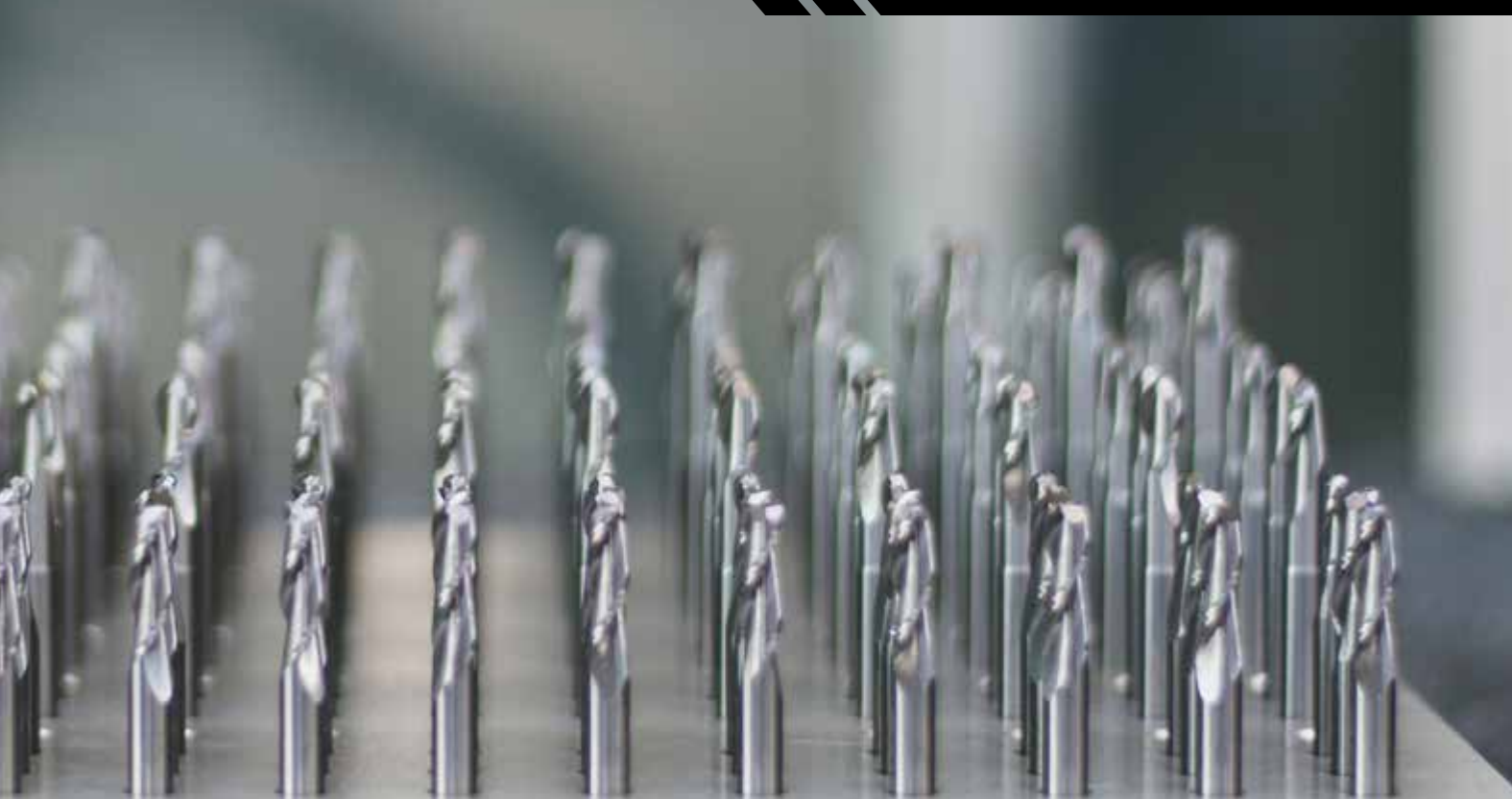

-5%	-10%	-20%
> 5 STK.	> 10 STK.	> 20 STK.
> 5 PCS.	> 10 PCS.	> 20 PCS.

FIRSTATTEC



KRAFTVOLL UND FLEXIBEL

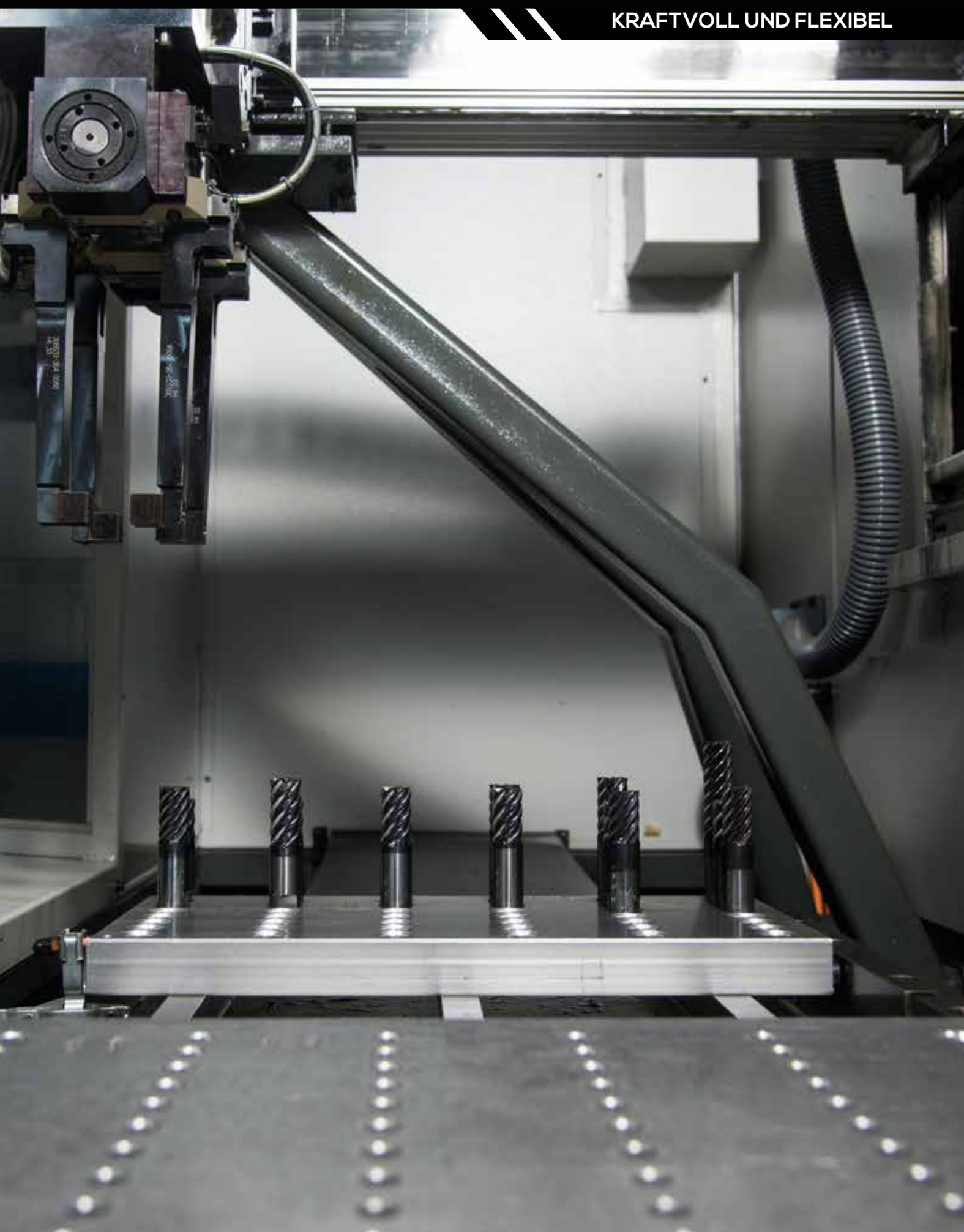

NUTFRÄSER

3-SCHNEIDER, ABGESTUFT SLOTING TOOL 3-FLUTE, STEPPED

Fräs Werkzeug zum Herstellen von T-Nuten.
Verschiedene Nutbreiten verfügbar. Fräsdurchmesser ist größer als Schaftdurchmesser.

Milling tool for producing T-slots.
Different groove widths available.
Milling diameter larger than shaft diameter.

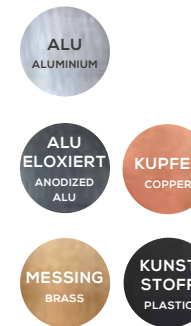
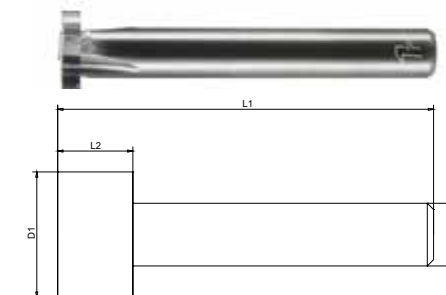

ART.-NR. ARTICLE-CODE	GEWINDE THREAD	D1 (h9)	D2 (h6)	D3	L1	L2	L3	R	α	PREIS PRICE
		(mm)	(mm)							(mm)
HANAN.										
060.03.010		6.0	3.0		50.0	1.0				60,00 €
060.03.015		6.0	3.0		50.0	1.5				61,00 €
080.06.015		8.0	6.0		60.0	1.5				66,00 €
080.06.020		8.0	6.0		60.0	2.0				67,00 €
100.06.020		10.0	6.0		60.0	2.0				78,00 €
100.06.025		10.0	6.0		60.0	2.5				79,00 €
140.08.025		14.0	8.0		60.0	2.5				98,00 €
140.08.030		14.0	8.0		60.0	3.0				99,00 €
200.10.030		20.0	10.0		60.0	3.0				148,00 €
200.10.040		20.0	10.0		60.0	4.0				149,00 €

-5%	-10%	-20%
> 5 STK.	> 10 STK.	> 20 STK.
> 5 PCS.	> 10 PCS.	> 20 PCS.

FIRSTATTEC

NOTIZEN

NOTES

Lined area for 'NOTIZEN' with horizontal lines for writing.

Lined area for 'NOTES' with horizontal lines for writing.



BESTELLABWICKLUNG

LIEFER- UND ZAHLUNGSBEDINGUNGEN DELIVERY AND PAYMENT

Im Preis enthalten ist der in der Auftragsbestätigung genannte Lieferungs- und Leistungsumfang. Nicht enthalten sind: die gesetzliche Umsatzsteuer, Versandkosten, Verpackungen, bei Exportlieferungen Zoll, Gebühren und sonstige öffentliche Abgaben. Von uns verauslagte Versandkosten werden weiterberechnet. Verpackung wird zum Selbstkostenpreis weiterberechnet. Innerhalb Deutschlands übernehmen wir ab einem Auftragswert von € 99,- netto Porto und Verpackungsgebühren (Sonderanfertigungen und Expresslieferungen sind ausgeschlossen).

Expresslieferungen machen wir auf Anfrage gerne möglich. Wir liefern ab Werk (EXW).

Ihre Zahlung erbitten wir innerhalb von 14 Tagen netto nach Rechnungsdatum. Gelten andere Zahlungsbedingungen zu Ihren Gunsten bestätigen wir dies schriftlich auf der Rechnung. Rechnungen übermitteln wir in elektronischer Form als PDF. Erteilen Sie uns eine Einzugsermächtigung durch ein SEPA Lastschriftmandat gewähren wir Skonto i.H.v. 4%.

Prices include the scope of delivery and services stated in the order confirmation. Not included: statutory sales tax, shipping costs, packaging, customs, fees and other public charges. Our incurred shipping costs will be charged. Packaging will be charged at cost. Within Germany we bear the expenses for postage and packaging fees from an order value of € 99, - net (custom and express deliveries are excluded).

Express deliveries are possible on request. We deliver ex works (EXW).

We request your payment within 14 days net after the invoice date. Other terms of payment in your favor are confirmed in writing on your invoice. We submit invoices in electronic form as PDF. For issuing us a direct debit authorization through a SEPA direct debit mandate we grant discount at 4%.

€	-5%	-10%	-20%
	> 5 STK. > 5 PCS.	> 10 STK. > 10 PCS.	> 20 STK. > 20 PCS.

Beachten Sie bei der Bestellung unsere Mengenrabatte!
Consider our quantity discounts for your order.

Der Katalog ist, einschließlich aller Texte und Bilder, urheberrechtlich geschützt. Änderungen und Irrtümer vorbehalten. Abbildungen ähnlich. Unsere Allgemeinen Geschäftsbedingungen finden Sie auf unserer Website unter www.firstattec.de

The catalog, including all texts and images, is protected by copyright. Changes and errors excepted. Similar pictures. Our terms and conditions can be found on our website at www.firstattec.de

